

Operating Instructions

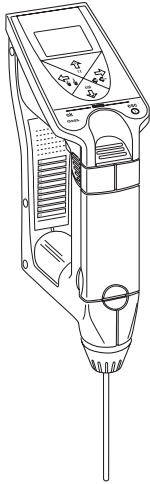

SG Ultra V1.0

Contents	Page
1 Introduction	3
2 Safety measures	3
3 Description of the instrument	4
3.1 SG-Ultra	4
3.2 Display	4
3.3 Keys	5
4 Tutorial	6
4.1 Inserting batteries	6
4.2 Configuration	6
4.3 Test measurement	7
4.4 Adjustment	7
4.5 Cleaning	8
4.6 Switching off and on	8
5 Menu (menu)	8
5.1 Using the menu	8
5.2 Measurement Unit (Measure Unit)	9
5.3 Temperature Unit (Temp. Unit)	11
5.4 Measure Mode	11
5.5 Adjustment Mode (Calib. Mode)	12
5.6 Interface	12
5.7 Beep	12
5.8 Background Lighting and LCD-Contrast (LCD)	12
5.9 Automatic Switch-off (Power)	12
5.10 Software Version (Version No.)	12
5.11 Date & Time	13
5.12 Identification	13
6 Measurement (meas)	13
6.1 Procedure for proper measurement	13
6.2 Filling the measuring cell using the built-in sample pump	14
6.3 Filling the measuring cell using an external syringe	14
6.4 Measuring	15
6.5 Saving the results	15
6.6 Displaying and marking saved results	16
6.7 Printing and transferring results	16
6.8 Deleting results	17
7 Adjustment (cal)	17
7.1 Adjusting the measuring cell with water	17
7.2 Adjusting the measuring cell with a density standard	18
7.3 Adjusting the measuring cell with air	19
7.4 Adjusting the temperature display	20
8 Interface	20
8.1 Eagle Eye printer (optional) settings	20
8.2 Data transfer to PC	21
8.3 Data format	21
9 Error messages and malfunctions	22
10 Cleaning and maintenance	22
10.1 Cleaning the measuring cell	22
10.2 Cleaning the housing	22
10.3 Replacing the sample tube	23
10.4 Replacing the sample pump	23

11	Standard and optional equipment	24
11.1	Standard equipment	24
11.2	Optional equipment	24
12	Technical data	25
13	Appendix	26
13.1	Density of pure water (0...40 °C)	26
13.2	Temperature-compensation coefficients α	26
	Index	27

1 Introduction

The Eagle Eye SG-Ultra is a portable measuring instrument suited for determining the density of liquids. The instrument uses the oscillating body method. To fill the measuring cell the built-in sample pump or a syringe may be used.

The results are automatically calculated into one of the following units: density, specific gravity, API degrees, Brix, % Alcohol, % H_2SO_4 , °Baumé, °Plato, Proof or a user-defined unit. The value is then shown on the backlit display.

For exact measurements, it is imperative to correct the temperature's influence on the density. Depending on the selected unit the SG-Ultra carries out this result correction automatically. For this task, the instrument uses either internally-stored tables or one of the 10 temperature-compensation coefficients entered by the user.

The results, along with the sample identification, temperature, temperature-coefficient, date and time can be saved. Together with the instrument identification they can then, via the integrated infrared interface, be transferred to the computer or printed out on a printer.

2 Safety measures

Measures for your protection



- Do not work in an explosion-hazardous environment! The instrument housing is not gastight. Otherwise, there is a risk of explosion from sparks and/or risk of corrosion by gasses which can seep in.



- Always hold the end of the sample tube over a waste container! There is a risk of injury when emptying corrosive substances.
- Leave the syringe in the sample intake after injecting a sample! Otherwise, the sample will run out of the measuring cell.

Measures for operational safety



- Never press on the measuring cell window! This can influence the oscillation characteristics of the measuring cell.
- Do not clean the measuring cell with concentrated NaOH (caustic soda) or HF (hydrogen fluoride)! Both substances chemically corrode the measuring cell.
- Use batteries of the specified type only. Otherwise, proper operation cannot be guaranteed.
- Do not submerge the housing in liquid! The instrument is only resistant to splashed water.
- Ensure that the following environmental conditions are met:
 - no strong vibrations present
 - not in direct sunlight
 - no high humidity present
 - no corrosive gasses present
 - temperature between -20 °C and 70 °C
 - no strong electrical or magnetic fields present

3 Description of the instrument

3.1 Densito 30PX

Illustration, see **rear fold-out page**

1	Backlit Display
2	Keypad
3	Drain button
4	Sample pump
5	Cover of sample pump
6	Connector for syringe adapter
7	Fixing screw for sample tube
8	Sample tube
9	Measuring cell
10	Infrared interface
11	Lock button
12	Fill button
13	Battery compartment cover

3.2 Display

Illustration, see **rear fold-out page**





1	Selected unit of measurement
2	Result
3	Sample identification (a...z or space)
4	Sample number, or error number if an error has occurred
5	Appears if Stability is set to Auto
6	Appears if Memory in is set to Auto
7	Appears if Memory out is set to Auto . If a printer or PC is connected, the data are transferred automatically
8	Battery-power indicator
9	Temperature (°C / °F)
10	Appears if delete mode is activated
11	Mark for results For the identification of invalid or incorrect results or for marking a sample change
Δ	Reference temperature (for the units "Comp. Density" and "SG" only)

3.3 Keys

Illustration, see **front fold-out page**

Red symbols: Press key longer than 2 seconds.

Blue symbols: Press key briefly.

No.	Symbol	Short key-press	Long key-press
1		<ul style="list-style-type: none"> • Move marker to the left • Mark saved results 	<ul style="list-style-type: none"> • Delete saved results
2		<ul style="list-style-type: none"> • Move marker upward • Select sample number (ascends) • Switch between Yes and No setting 	<ul style="list-style-type: none"> • Select temperature-compensation coefficient α
3		<ul style="list-style-type: none"> • Move marker to the right • Display saved results • Transfer one saved result to a printer/PC 	<ul style="list-style-type: none"> • Transfer a series of saved results to a printer/PC
4		<ul style="list-style-type: none"> • Move marker downward • Select sample number (descends) • Switch between Yes and No setting 	<ul style="list-style-type: none"> • Call up adjustment mode
5	esc	<ul style="list-style-type: none"> • Exit the menu 	<ul style="list-style-type: none"> • Switch instrument on or off
6	ok/meas.	<ul style="list-style-type: none"> • Start measurement • Confirm input • Confirm data delete • Confirm data transfer • While pressing and holding key 5: enter the menu 	

Only the arrow symbols are used to represent keys 1 – 4 in the following operating instructions.

4 Tutorial

4.1 Inserting batteries

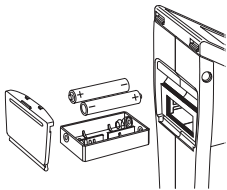

- Open the battery compartment cover on the back of the Densito 30PX.
- Remove battery compartment.
- Insert batteries into the battery compartment, observing correct polarity.
- Insert battery compartment, ensuring that the contacts of the battery compartment face the instrument.
- Close battery compartment cover.

The instrument switches on automatically and is immediately ready for operation. With the backlighting switched off the battery lasts about 90 hours.

If nothing appears in the display

- Check polarity of the batteries and battery compartment.

4.2 Configuration

Configuring the instrument for test measurement.

Entering the menu

- Press the keys **ok/meas.** and **esc** simultaneously.

The instrument switches to the **FUNCTION** menu, **Measure Unit** appears in reverse display (white on black).

Selecting setting

- Confirm **Measure Unit** by pressing the **ok/meas.** key.
- Press the **↓** key repeatedly until **SG (t/t)** is marked.
- Confirm **SG (t/t)** by pressing the **ok/meas.** key.

Setting date and time

- Use the **↓** key to switch to **Date & Time**.
- Confirm **Date & Time** with the **ok/meas.** key.
- To set the date, confirm **Date** with the **ok/meas.** key.
- Use the side arrows to select the number to change, and use the up and down arrows to change the value. Confirm with **ok/meas.**
- Use the down arrow key to switch to **Time** and confirm with **ok/meas.** Set the time as described above.

Exiting the menu

- Press the **esc** key.

The instrument is configured for test measurement.

4.3 Test measurement

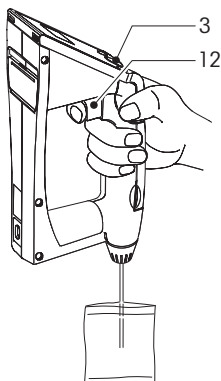

- Push drain button (3) downward completely.
- Ensure that the sample tube is located in the accompanying density standard or in distilled water.
- Press the fill button (12) slowly to fill the measuring cell.
- Ensure that no air bubbles are contained within the measuring cell.
- Press the **ok/meas.** key.

The instrument automatically executes a measurement and the result appears in reverse display.

The result for water must be 1.000 in the selected measurement unit SG (t/t).

If the deviation is < 0.0005

Adjustment is ok, the instrument is ready for measurement.

If the deviation is > 0.0005

Adjust instrument, see Chapter 4.4.

4.4 Adjustment

Initializing adjustment

- Press and hold the ↓ key until **CALIB (Water)** appears on the display. The instrument adjusts automatically (duration: approx. 1 minute). After adjustment is completed, the measured deviation from the theoretical value and Execute? (**No**) appears.
 - Press the ↑ or ↓ key. Execute? (**Yes**) appears.
 - Press the **ok/meas.** key to confirm.
- The adjustment is confirmed.

4.5 Cleaning

The built-in sample pump or an external syringe can be used to fill the measuring cell with cleaning liquid.

- Empty the measuring cell completely before cleaning. Press the drain button downward completely.
- Clean the measuring cell daily with a suitable cleaning liquid.
- For very dirty measuring cells, let the inside of the cell soak in the cleaning liquid.
- Repeat cleaning if necessary.
- If the housing is soiled, clean with a cleaning tissue.

4.6 Switching off and on

Switching off

- Press and hold the **esc** key until the display is turned off. The instrument is now turned off.

Switching on

- Press and hold the **esc** key until the display appears. The instrument is ready for operation.

5 Menu (menu)

The menu of the SG-Ultra offers the following functions:

- Measurement Unit (Measure Unit) see Chapter 5.2
- Temperature Unit (Temp. Unit) see Chapter 5.3
- Measure Mode see Chapter 5.4
- Adjustment Mode (Calib. Mode) see Chapter 5.5
- Interface see Chapter 5.6
- Beep see Chapter 5.7
- Backlighting and LCD-Contrast (LCD) see Chapter 5.8
- Automatic Switch-off (Power) see Chapter 5.9
- Software Version (Version No.) see Chapter 5.10
- Date & Time see Chapter 5.11
- Identification see Chapter 5.12

5.1 Using the menu

Entering the menu

- Press the keys **ok/meas.** and **esc** simultaneously. The instrument switches to the menu.

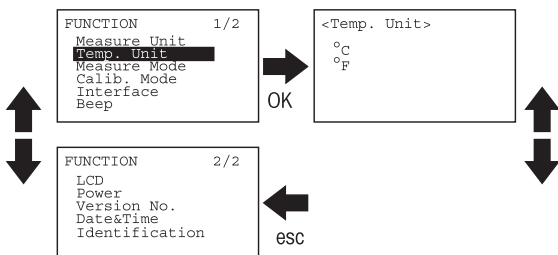

Selecting functions

- Press the **↓** and **↑** keys repeatedly until the desired function is marked.
- Press the **ok/meas.** key to activate the marked function.

The instrument switches to the corresponding submenu or activates the desired function.

Numerical input

- Select decimal places with the **←** and **→** keys.
- Change value with the **↓** and **↑** keys.
- Press the **ok/meas.** key to confirm the value.

Exiting the menu

- Press the **esc** key.

5.2 Measurement Unit (Measure Unit)

The following units are available for selection:

Density

Available density units:

g/cm³

lb/gal (US) 1 g/cm³ = 8.3454 lb/gal

lb/gal (IP) 1 g/cm³ = 10.0224 lb/gal

Comp. Density (Temperature-compensated density)

Density measurement in g/cm³ at a reference temperature.

All results at the same reference temperature (T_0 , e.g. 20 °C), regardless of the measuring temperature (T).

Compensated density = measured density • (1 + α • (T - T_0))

10 temperature-compensation coefficients can be saved.

The following input is required:

Comp. No. Number of the temperature-compensation coefficient (0...9)

Comp. Temp. Reference temperature (T_0)

$\alpha \times 1000$ Temperature-compensation coefficient

For typical temperature-compensation coefficients, see Chapter 13.2; calculation of α , see page 11.

SG (t/t) (specific gravity)

$$SG (t/t) = \frac{\text{Density of the sample at } T}{\text{Density of water at } T}$$

T Measuring temperatures

SG (specific gravity, temperature-compensated)

$$SG = \frac{\text{Density of the sample, temperature-compensated for } T_0}{\text{Density of water at } T_1}$$

10 temperature-compensation coefficients can be saved.

The following input is required:

Comp. No. Number of the temperature-compensation coefficient (0...9)

Comp. T. T_0/T_1 °C (enter temperatures T_0 and T_1)

$\alpha \times 1000$ Temperature-compensation coefficient

For typical temperature-compensation coefficients, see Chapter 13.2; calculation of α , see page 11.

API (American Petroleum Institute)

The measured values are converted to a reference temperature of 15 °C or 60 °F. This conversion is based on API tables: product group A: crude oil; product group B: fuel, petroleum products; product group D: lubricants. The result can be expressed as density (e.g. API A (Density)), or directly in API degrees (e.g. API A (degrees)).

Brix (Sucrose)

Measurement of the sucrose concentration, percent weight at 20 °C.

Alcohol (Ethanol)

Measurement of the ethanol concentration in water, percent weight (Wt%) or percent volume (Vol%) at 20 °C.

H2SO4 (Sulphuric acid concentration)

Measurement of the sulphuric acid concentration, percent weight at 20 °C.

Baume (°Baumé scale)

Measurement in °Baumé (heavy Baumé for $d > 1$, light Baumé for $d < 1$) calculated to a reference temperature.

10 temperature-compensation coefficients can be saved.

Input of temperature-compensation coefficients via Comp. Density.

For typical temperature-compensation coefficients, see Chapter 13.2; calculation of α , see page 11.

Plato

Measurement of the °Plato at 20 °C.

Proof

Measurement of the Proof degree at 60 °F.

The Proof degree is a unit used to determine the ethanol content.

Proof (US): Measurement with US unit (100 v/v % = 200 US Proof).

Proof (IP): Measurement with IP unit (100 v/v % = 175 British Proof).

Conc. (Concentrations)

Measurement of the concentration via the input of the desired concentration-conversion formula $y = a + bx$ at a reference temperature.

y = concentration in % or without units

a, b = sample-dependent coefficients

x = measured density. The following units are possible for x :

- 1/compensated density – 1
- compensated density – 1
- compensated density
- 1/specific gravity – 1
- specific gravity – 1
- specific gravity

Calculation of the temperature-compensation coefficient α

- Measure density of the sample:

- at a temperature (T_1) above the normal measuring temperature,
- at a temperature (T_2) below the normal measuring temperature.

- Calculate α according to the formula:

$$\text{density at } T_2 = \text{density at } T_1 \cdot (1 + \alpha \cdot (T_1 - T_2))$$

or

$$\alpha = \left(\frac{\text{density at } T_2}{\text{density at } T_1} - 1 \right) / (T_1 - T_2)$$

- Enter value $\alpha \times 1000$ into the instrument.

Note

The temperatures T_1 and T_2 have to be entered in the selected unit ($^{\circ}\text{C}$ or $^{\circ}\text{F}$, see chapter 5.3).

Example

(measured) density at 26°C (T_1) 0.7844 g/cm^3

(measured) density at 15°C (T_2) 0.7937 g/cm^3

$$\alpha = \left(\frac{0.7937}{0.7844} - 1 \right) / (26 - 15)$$

$$\alpha = (1.011856 - 1) / 11 = 0.011856 / 11 = 0.001078$$

$\alpha \times 1000 = 1.078$; enter this value into the instrument.

10 temperature-compensation coefficients can be saved.

Input of temperature-compensation coefficients via Comp. Density.

For typical temperature-compensation coefficients, see Chapter 13.2.

5.3 Temperature Unit (Temp. Unit)

Data in $^{\circ}\text{C}$ or $^{\circ}\text{F}$ (selectable).

5.4 Measure Mode

Configuration of sample identification, stability mode and method of data storage.

Sample Name	Sample identification. A letter (a...z or space) can be set for the identification of samples.
Stability	Stability control.
Auto	The result is accepted automatically when the display is stable.
Manu	Result accepted by pressing the ok/meas. key.
Mode	Method of data storage.
Labo	By pressing the ok/meas. key the result is saved and transferred (printer, PC).
Field	By pressing the ok/meas. key the result is saved.
Custom	User-defined setting.
Memory in	Save results.
Auto	Save result automatically.
Manu	Result saved by pressing the ok/meas. key.
Memory out	Transfer result to PC or printer.
Auto	Transfer result automatically.
Manu	Transfer result by pressing the → key.

5.5 Adjustment Mode (Calib. Mode)

Off Adjust measuring cell with accompanying density standard or distilled water.

On Adjust measuring cell with desired density standard.

The following input is required:

Density	Density of the density standard (g/cm ³) at the reference temperature.
Temp	Reference temperature
$\alpha \times 1000$	Temperature-compensation coefficient of the density standard • 1000

5.6 Interface

PRN Printer interface

Data transfer to the printer

Printer with serial interface and connected infrared adapter. Results are formatted for output to a printer.

Transfer rate (baud rate), parity and stop and data bits must be configured according to the peripheral device.

The following settings are required for the Eagle Eye Printer:

Baud rate 9600

Parity none

Stop bits 1

Data bits 8

RS Serial interface. The Excel macro "PortableCapf" for data transfer to the computer via the infrared adapter is located on the HelloCD (optional).

IrDA Data transfer to the PC with the integrated IrDA interface in accordance with protocol 1.20.

5.7 Beep

Off Beep off.

On Beep on.

5.8 Background Lighting and LCD-Contrast (LCD)

Backlighting

The backlighting is turned off automatically 5 seconds after the last time a key has been pressed (**Auto off**), or it is always off (**Always off**).

Contrast

Display contrast is adjustable to one of 9 levels with the **← →** keys.

5.9 Automatic Switch-off (Power)

Off Automatic switch-off off. The instrument must be switched off manually.

On The instrument switches off automatically if not operated for 10 minutes.

5.10 Software Version (Version No.)

The software version is displayed.

5.11 Date & Time

The settings for date and time can be edited here. The date is displayed in the format year/month/day (e.g. 2003/03/04 for March 4, 2003). Both date and time are included in the data transfer to a printer or computer.

5.12 Identification

An identification consisting of 10 letters and numbers (instrument name, user, etc.) may be entered here. This identification will be included in the data transfer to a printer or computer.

6 Measurement (meas)

6.1 Procedure for proper measurement

- Test the instrument for accuracy with the accompanying density standard or distilled water before beginning any measurements (see Chapter 4.3).
- Ensure that the measuring cell is clean before each measurement. Insufficient cleaning leads to remaining residue in the measuring cell and, therefore, incorrect results.
- Check the sample for chemical resistance of the instrument materials.
 - Sample tube: PTFE (polytetrafluorethylene)
 - Measuring cell: Borosilicate glass
 - Measuring cell holder: PPS (polyphenylene sulphide)
 - Sample pump: PP (polypropylene)
- Ensure that the samples to be measured:
 - are liquid enough to be sucked up or injected;
 - can be dissolved with a solvent suitable for cleaning the measuring cell;
 - are homogeneous (no emulsions or suspended particles, no air bubbles);
 - have reached ambient temperature in the measuring cell.

For samples which are 20 °C colder than the ambient temperature:

- Heat the sample before beginning the sampling procedure.

Note

The unit display flashes when the difference in temperature between the sample and the ambient air is greater than ± 5 °C.

For samples of high viscosity (> 2000 mPa·s):

- Use an external syringe to fill the measuring cell.

6.2 Filling the measuring cell using the built-in sample pump

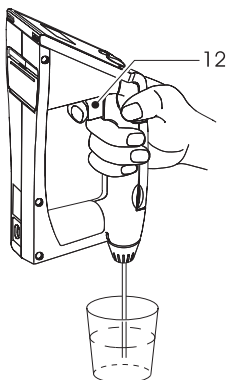

- Ensure that the sample tube is in the sample.
- Press the fill button (12) slowly to fill the measuring cell.
- Ensure that there are no air bubbles in the measuring cell.

6.3 Filling the measuring cell using an external syringe

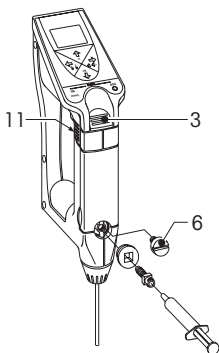

- Press the drain button (3).
- Slide up the lock button (11).
- Remove the screw stopper (6) with a coin.
- Screw in the adapter for the external syringe.
- Hold the sample tube over a waste container.
- Slowly inject the sample into the measuring cell.
- Ensure that there are no air bubbles in the measuring cell.
- Do not remove the syringe while measuring.

6.4 Measuring

The procedure is dependent upon the settings in the menu, see Chapter 5.4.

The  symbol appears in the display: Measuring with automatic stability control

- Press the **ok/meas.** key to start measuring.

The  symbol blinks during measurement. The result appears in reverse display.

The  symbol does not appear on the display: Measuring with manual stability control



The instrument measures continuously.

- Wait until the displayed value stabilizes.
- If the result is to be saved: Press the **ok/meas.** key.

The result appears in reverse display.

Measuring with temperature-compensation coefficients (α)

(Comp. Density, SG, Conc. or Baume on the display)

- Press the  key until a previously-saved temperature-compensation coefficient appears in the display, e.g. **$\alpha.1=0.132$** .
- Select the desired coefficient using the  and  keys.
- Confirm the selected coefficient with the **ok/meas.** key.
- Measure using either automatic or manual stability control.

Emptying the measuring cell

- Hold the sample tube over a waste container.
- Press drain button (3) downward slowly and move it up again with the fill button (12).

6.5 Saving the results

The instrument can save up to 1100 results internally. Each time a result is saved, the number of internally-stored values increases by one.

The procedure for saving the results is dependent upon the settings in the menu (see Chapter 5.4).

The  symbol appears in the display: Saving all results automatically

The instrument saves all results automatically.

The  symbol does not appear in the display: Saving selected results manually

Save the result:

- Press the **ok/meas.** key.

Do not save the result:

- Press the **esc** key.

6.6 Displaying and marking saved results

Displaying saved results

- Press the ← key.

The sample number flashes and the symbol ☒ appears.

- Scroll through the saved results using the ↑ and ↓ keys.

Marking results

For the identification of invalid or incorrect results or for marking a sample change.

- Select the desired sample number using the ↑ and ↓ keys.
- Press the **ok/meas.** key.

The selected sample number is marked with an asterisk.

Note

The marking is removed if the sample has already been marked.

6.7 Printing and transferring results

Conditions

- The interface and peripheral device are configured properly, see Chapter 5.6 and Chapter 8.
- For PRN and RS interfaces, the infrared adapter must be connected to the printer/PC.

The procedure for printing and transferring results is dependent upon the settings in the menu (see Chapter 5.4).

Important

To transfer or print results, hold the instrument in the direction of the infrared adapter at a maximum distance of approx. 20 cm.

The ☒ symbol appears in the display: Printing or transferring results automatically

Every displayed result is transferred automatically.

The ☒ symbol does not appear in the display: Printing or transferring selected results manually

- Press the → key.
- Select desired result with the ↑ or ↓ key.
- Press the **ok/meas.** key to transfer/print the result.

The ☒ symbol flashes and the result is transferred.

Printing and transferring results of a series of samples manually

- Press and hold the → key until **Memory out**, Execute? (**All**) appears in the display.
- Press the ↑ or ↓ key.
Execute? (**Range**) appears.
- Press the **ok/meas.** key to confirm.
- Enter the desired series of samples (from ... to ...) using the arrow keys.

To transfer the series of samples:

- Press the **ok/meas.** key.

The sample series (from ... to ...) is confirmed. The ☒ symbol flashes and the results of the selected series of samples are transferred.

To print or transfer all results manually

- Press and hold the **→** key until **Memory out**, Execute? (**All**) appears in the display.
- Press the **ok/meas.** key.

The **↑** symbol in the display flashes and all results are transferred.

After a successful transfer, the user is asked whether he/she would like to delete the transferred results: **Memory All Clear** Execute? (**No**).

Leaving transferred results in tact

- Confirm **Memory All Clear** Execute? (**No**) by pressing the **ok/meas.** button.

Deleting transferred results

- Press the **↑** or **↓** key.
Execute? (**Yes**) appears.
- Press the **ok/meas.** key to confirm.

All results are deleted.

6.8 Deleting results

It is not possible to delete individual results with the SG-Ultra.

Deleting all results

- Press and hold the **←** key until **Memory All Clear** Execute? (**No**) appears in the display.
- Press the **↑** or **↓** key.
Execute? (**Yes**) appears.
- Press the **ok/meas.** key to confirm.

All results are deleted.

7 Adjustment (cal)**Before adjusting**

- Carry out a test measurement before adjusting the measuring cell, see Chap. 4.3.

Test measurement result < 0.9995 or > 1.0005

- Check if the measuring cell is dirty, clean if necessary and repeat the test measurement.

Test measurement result once again < 0.9995 or > 1.0005

- Readjust instrument.

7.1 Adjusting the measuring cell with water**Settings in the menu**

- Calib. Mode: off

Adjusting

- Ensure that the measuring cell and sample tube are clean.
- Fill the clean measuring cell with the accompanying density standard or distilled water and ensure that no air bubbles are allowed to enter.
- Press and hold the **↓** key until **CALIB (Water)** appears in the display.

The instrument adjusts automatically (duration: approx. 1 minute). After adjustment is completed, the measured deviation from the theoretical value and Execute? (**No**) appears.

Measured deviation < 0.001

- Press the **↑** or **↓** key.
Execute? (**Yes**) appears.
- Press the **ok/meas.** key to confirm.

The adjustment is confirmed.

Measured deviation ≥ 0.001

- Check whether the measuring cell is dirty and if there are air bubbles.

Measuring cell is clean and contains no air bubbles:

- Press the **↑** or **↓** key.
Execute? (**Yes**) appears.
- Press the **ok/meas.** key.

Measuring cell is dirty and/or contains air bubbles:

- Execute? (**No**) is confirmed by pressing the **ok/meas.** button.
- Clean the cell if necessary and readjust.

7.2 Adjusting the measuring cell with a density standard

If a different density range is to be used, the measuring cell can be adjusted using a density standard of your choice (e.g. toluene from the NIST, National Institute of Standards and Technology) instead of distilled water.

Setting in the menu

- **Calib. Mode:** On
- Enter the following density standard values into the menu:
Density Density of the density standard (g/cm³) at the reference temperature
Temp Reference temperature
 $\alpha \times 1000$ Temperature-compensation coefficient of the density standard • 1000

Adjusting

- Ensure that the measuring cell and sample tube are clean.
- Fill the clean measuring cell with the density standard (e.g. Toluene) ensuring that no bubbles are allowed to enter.
- Press and hold the up and down keys simultaneously until **CALIB (STD)** appears in the display.

The instrument adjusts automatically (duration: approx. 1 minute). After adjustment is completed, the measured deviation from the theoretical value and Execute? (**No**) appears.

Measured deviation < 0.001

- Press the **↑** or **↓** key.
Execute? (**Yes**) appears.
- Press the **ok/meas.** key.

The adjustment is confirmed.

Measured deviation ≥ 0.001

- Check whether the measuring cell is dirty and if there are air bubbles.

Measuring cell is clean and contains no air bubbles:

- Press the **↑** or **↓** key.
Execute? (**Yes**) appears.
- Press the **ok/meas.** key.

Measuring cell is dirty and/or contains air bubbles:

- Execute? (**No**) is confirmed by pressing the **ok/meas.** button.
- Clean the cell and readjust if necessary.

7.3 Adjusting the measuring cell with air

The SG-Ultra measures with the specified accuracy if the measuring cell is correctly adjusted with the accompanying density standard or distilled water. Additional adjustment with air is generally not necessary, but is recommended when:

- the measuring cell is replaced,
- the displayed density of air is $< 0.0007 \text{ g/cm}^3$ or $> 0.0015 \text{ g/cm}^3$.

Setting in the menu

Calib. Mode: Off.

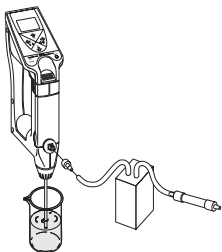

Preparing the measuring cell

- Clean the measuring cell with a suitable solvent and rinse with ethanol.
- Hold the sample tube over a waste container.
- Connect a tube from the connection of the external syringe to an air pump (volume flow 1...2 l/min) connected to dry tube filled with 5...10 g silica gel.
- Dry measuring cell for approx. 5...10 min.
- Wait approx. 30 min. until the measuring cell has reached the ambient temperature.

Adjusting

- Press the \uparrow and \downarrow keys simultaneously.

CALIB (Air) appears in the display. The instrument adjusts the measuring cell automatically.

Adjustment is complete when **CALIB (Air)** disappears (after approx. 2 min.).

- Adjust measuring cell with water or a density standard of your choice.

7.4 Adjusting the temperature display

Adjustment of the temperature display is generally not necessary, as the SG-Ultra was adjusted at the factory before shipment.

If the displayed temperature deviates from the actual temperature, carry out the following steps for adjustment:

- Check settings in the Measure Mode menu.

Stability: Manu

Memory in: Manu

- Switch instrument off.
- Set instrument aside for approx. one hour at a constant temperature.
- Switch instrument on.
- Press the **ok/meas.** key briefly; the display appears in reverse.
- Read temperature on the instrument and from an external thermometer.
- Determine and log the difference between the actual temperature (external thermometer) and the temperature displayed on the instrument.
- Press the **↓** and **→** keys simultaneously.

CALIB (°C) or **CALIB (°F)** (depending on the selected temperature unit) appears, and the unit flashes.

- Enter the logged temperature difference (with sign) using the arrow keys.
- Press the **ok/meas.** key.

The temperature display is adjusted.

Example

Displayed value on instrument:	21.7 °C
Actual temperature:	21.3 °C
Difference:	$21.3\text{ °C} - 21.7\text{ °C} = -0.4\text{ °C}$
Value to be entered:	-0.4 (°C)

8 Interface

Using the infrared interface of the SG-Ultra, the stored measurements together with the sample identification, the measurement unit, the temperature, the temperature compensation coefficient, the instrument identification, date and time can be printed out with a printer or transferred to a PC.

An infrared adapter or a PC/printer with an IrDA interface is required.

Important

Data transfer is only possible when:

- there is visual contact between the infrared adapter and the infrared interface;
- the distance between the SG-Ultra and the infrared adapter is no more than 20 cm.

8.2 Data transfer to PC

- Configure the infrared interface of the SG-Ultra as follows (Interface, see chapter 5.6):
 - Interface: RS
 - Baud rate: 9600
 - Parity: None
 - Stop Bits: 1
 - Data Bits: 8
- Connect the infrared adapter to an available serial interface (COM1, COM2, ...) on the PC.
- Insert the (optional) HelloCD™ into the CD-ROM drive of the PC.
- Install the PortableCapt program (Excel macro).
- Start the PortableCapt program on the PC.
- In the Excel macro: select the serial interface (COM1, COM2, ...) to which the infrared adapter is connected.
- For further procedures see Chapter 6.7.

8.3 Data format

If RS is selected as interface, the data is transferred in the following format:

Type	1)			Sample No.			2)		
Data column	STX	,	,	,	,	,	,	,	,
Start Byte = 0	1	1	1	4			1	1	1

Type	Date & Time 3)																
Data column																	,
Start Byte = 10	16																1

Type	Result							Unit											
Data column							,										,		
Start Byte = 27	7							1	10										1

Type	Temperature						4)			α ⁶⁾ 6)			α-value ⁶⁾			
Data column						,	,								,	
Start Byte = 46	5						1	1	1	1	1	1	5			1

Type	Identification										CR	LF	EOT
Data column													
Start Byte = 63	10										1	1	1

- 1) Sample identification (a...z, space)
- 2) If result is marked (*); otherwise, space
- 3) Format yyyy/mm/dd hh:mm
- 4) Temperature unit (°C or °F)
- 5) Number of the temperature-compensation coefficient
- 6) These bytes contain only spaces, unless Comp. Density, SG, °Baumé or Conc. is selected as the result unit

9 Error messages and malfunctions

Error	Possible causes	What to do
E-01	Adjustment error: <ul style="list-style-type: none"> • Measuring cell not filled with water • Air bubbles in measuring cell • Sample tube defective • Measuring cell is dirty • Measuring cell defective 	<ul style="list-style-type: none"> - Fill measuring cell with water - Use bubble-free, distilled water - Replace sample tube - Clean measuring cell - Call Eagle Eye Service
E-02	Measuring cell fault <ul style="list-style-type: none"> • Measuring cell is dirty • Measuring cell defective 	<ul style="list-style-type: none"> - Clean measuring cell - Call Eagle Eye Service
E-03	Sample temperature not measured correctly	<ul style="list-style-type: none"> - Call Eagle Eye Service
E-04	Error in ambient temperature measurement	<ul style="list-style-type: none"> - Call Eagle Eye Service
E-05	Full appears instead of a sample number: Data memory full	<ul style="list-style-type: none"> - Delete data from memory
E-06	Memory fault	<ul style="list-style-type: none"> - Call Eagle Eye Service
E-07	Measuring time of 10 minutes exceeded	<ul style="list-style-type: none"> - Switch instrument off and on again - Measure using bubble-free, distilled water If error appears again: <ul style="list-style-type: none"> - Call Eagle Eye Service
BATT	Batteries empty	<ul style="list-style-type: none"> - Replace batteries (see Chapter 4.1)
	Result = 0.0000 or strongly negative results: Menu setting incorrect	<ul style="list-style-type: none"> - Set Calib. Mode to off

10 Cleaning and maintenance

10.1 Cleaning the measuring cell

The built-in sample pump or an external syringe can be used to fill the measuring cell with cleaning liquid.

- Clean measuring cell daily with a suitable cleaning liquid.
- For a very dirty measuring cell let the inside of the cell soak with cleaning liquid.
- Repeat cleaning if necessary.

10.2 Cleaning the housing

- Never use aggressive liquids or solvents to clean the housing of the SG-Ultra!
- We recommend that you use the cleaning tissues which come with the instrument.

10.3 Replacing the sample tube

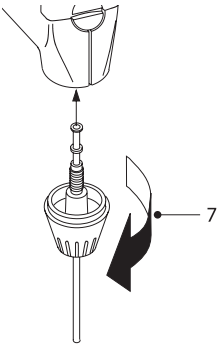

- Loosen fixing screw (7) of sample tube in the direction of the arrow and remove old sample tube.
- Insert new sample tube with washer into screw gland of sample tube.
- Tighten screw gland of sample tube to instrument by hand.
- Check sample tube for secure seating.

10.4 Replacing the sample pump

Removing cover of sample pump

- Slightly press together cover of sample pump on grip recesses and detach it.
- Pull sample pump out of guide system.

Inserting sample pump

- Insert new sample pump into guide system.

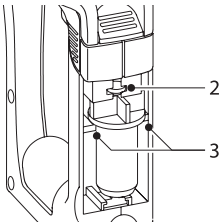

Ensure that the pump plunger (2) and pump body (3) are situated in the corresponding guides when inserting the sample pump.



- Check for proper functioning of sample pump.
- Put the cover of the sample pump back in its place.

11 Standard equipment

Each part identified by an order number can be ordered from Eagle Eye.

11.1 Standard equipment

The instrument is delivered pre-assembled.

		Order No.
1	SG-Ultra density meter with carrying case, includes:	SG-Ultra
2	AAA-type batteries (LR03, 1.5 V)	
2	Vials with screw cap (PE)	
1	Operating instructions	

12 Technical data

Measurement principle	Density measurement using the oscillating body method
Sample intake	Using the built-in sample pump or an external syringe
Range of density measurement	0.0000...2.0000 g/cm ³
Accuracy	±0.001 g/cm ³
Resolution	0.0001 g/cm ³
Working temperature	5...35 °C
Storage temperature	-20...70 °C
Temperature accuracy	±0.2 °C
Measurement range Brix (d)	0.0...84.0 %
Accuracy	±0.3 %
Measurement range Ethanol (d) wt%	0.0...100.0 %
Accuracy	±1.0 %
Measurement range Ethanol (d) vol%	0.0...100.0 %
Accuracy	±1.0 %
Measurement range H ₂ SO ₄	0.0...100.0 %
Accuracy	±1.0 %
Measurement range light Baumé	10...100 °Baumé
Accuracy	±0.4 °Baumé
Measurement range heavy Baumé	0...72 °Baumé
Accuracy	±0.1 °Baumé
Measurement range Plato	0.0...20.0 %
Accuracy	±0.3 %
Measurement range Proof (US)	0.0...200.0
Accuracy	±2.0
Measurement range Proof (IP)	0.0...175.0
Accuracy	±1.75
Display	Backlit LC-Display
Materials	
Housing	PBT (polyester)
Measuring cell	Borosilicate glass
Materials which contact the product	PTFE (polytetrafluoroethylene) Borosilicate glass PPS (polyphenylene sulfide) PP (polypropylene)
Weight	approx. 360 g
Measuring time per sample	1...10 minutes
Data memory	1100 results
Interface	Infrared for printer and PC
Battery operation	2 x 1.5 V batteries (LR03); type AAA
Battery lifetime	approximately 90 hours (with backlighting off)

Subject to technical changes.

13 Appendix

13.1 Density of pure water (0...40 °C)

Temperature [°C]	Density [g/cm ³]	Temperature [°C]	Density [g/cm ³]
0	0.99984		
1	0.99990	21	0.99799
2	0.99994	22	0.99777
3	0.99996	23	0.99754
4	0.99997	24	0.99730
5	0.99996	25	0.99705
6	0.99994	26	0.99679
7	0.99990	27	0.99652
8	0.99985	28	0.99624
9	0.99978	29	0.99595
10	0.99970	30	0.99565
11	0.99961	31	0.99534
12	0.99950	32	0.99503
13	0.99938	33	0.99471
14	0.99925	34	0.99438
15	0.99910	35	0.99404
16	0.99894	36	0.99369
17	0.99878	37	0.99333
18	0.99860	38	0.99297
19	0.99841	39	0.99260
20	0.99821	40	0.99222

[Chemical Handbook Fundamental Version, Rev. 3, Table 5.2 (1984)]

13.2 Temperature-compensation coefficients α

Substance	Temperature range [°C]	$\alpha \cdot 10^3 / ^\circ\text{C}$
Water	15...30	0.23
Ethanol	0...30	1.09
m-xylene	0...30	0.99
p-xylene	15...30	1.02
Glycerine	15...30	0.49
Chloroform	0...30	1.26
Carbon tetrachloride	0...30	1.22
Toluene	0...30	1.07
Benzene	6...30	1.21
Methanol	6...30	1.18
Acetone	0...30	1.42
Bromobenzene	0...30	0.91
Cyclohexane	0...30	1.20
Isopropanol	0...30	1.06
n-nonane	0...30	1.08

Index

A

Adjusting the temperature display 20
Adjustment 17
Adjustment mode 12
Alcohol 10
API (American Petroleum Institute) 10
Automatic saving 11, 15
Automatic stability control 11, 15
Automatic switch-off 12

B

Backlighting 12
Backlit Display 4
Battery 4, 6, 24
Baud rate 12, 20
Baumé 10
Beep 12
Brix 10

C

Cal 17, 18, 19, 20
Calib. Mode 12
Cleaning 8, 22
Cleaning cloths 24
Comp. Density 9
Conc. 10
Concentrations 10
Configuring 6

D

Data bits 12, 20
Data format 21
Data storage 11
Data transfer 12, 13, 21
Date 6, 13
Deleting results 17
Density of pure water 26
Density standards 24
Display 4
Displaying / marking saved results 16

E

Errors 22
Ethanol 10
Excel macro 21

F

Fault messages 22
Field 11
Filling button 4

H

H2SO4 10
Heavy Baumé 10

I

Identification 13
Infrared adapter 12, 20, 24
Infrared interface 4, 20
Interface 12, 21
Interface description 20
IrDA 12
IrDA interface 12, 20

K

Keypad 4

L

Labo 11
Light Baumé 10
Locking button 4

M

Maintenance 22
Manual saving 11, 15
Manual stability control 11, 15
Measure Mode 11
Measure Unit 9
Measurement 13
Measuring 15
Measuring cell 4, 22
Menu 6, 8
Mode 11

O

O-ring 24

P

Parity 12, 20
Pipettes 24
Plato 10
PortableCapt 12, 21
Power 12
Printer 20, 24
Printing and transferring results 16
PRN 12
Proof 10
Protocol 12

R

Result 4

RS 12

S

Safety measures 3

Sample identification 4, 11

Sample name 11

Sample pump 4, 23, 24

Sample tube 4, 23, 24

Saving the results 15

Scope of delivery 24

SG (t/t) 9

Software version 12

Specific gravity 9

Specific gravity, temperature-
compensated 9

Stability 11

Stability control 11

Stability mode 11

Stop bits 12, 20

Sucrose 10

Sulphuric acid concentration 10

Switching off 8

Switching on 8

T

Technical data 25

Temp. Unit 11

Temperature unit 4, 11

Temperature-compensated density 9

Temperature-compensation
coefficients 9, 11, 15, 26

Test measurement 7

Time 6, 13

U

Unit of measurement 4

V

Version No. 12

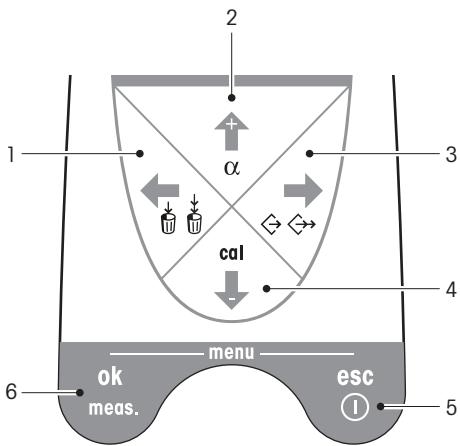

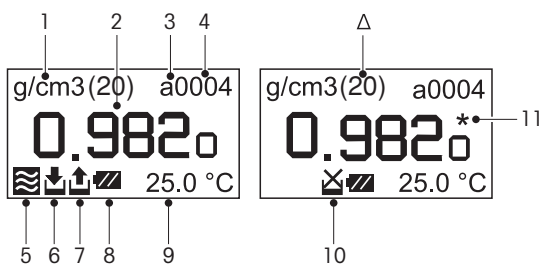
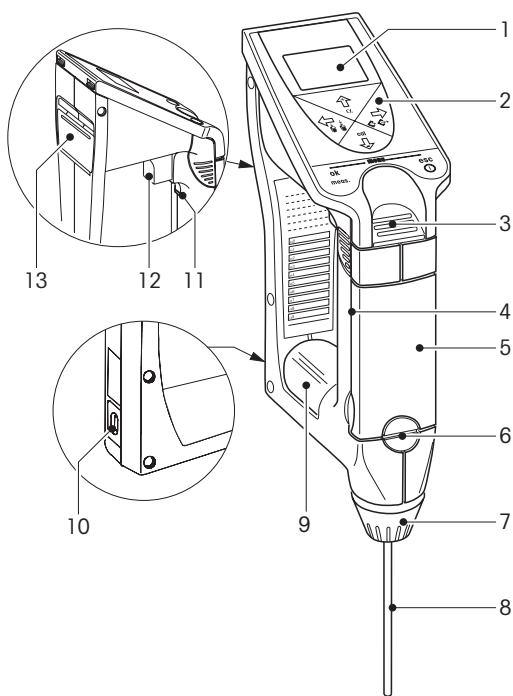

Subject to technical changes and to the availability
of the accessories supplied with the instruments.

© Eagle Eye Power Solutions. ALL RIGHTS RESERVED.

Eagle Eye Power Solutions
4031 W Kiehnau Ave, Milwaukee WI, 53209
Tel. (877) 805 3377, Fax (414) 962 3660,
<http://www.eepowersolutions.com>