



# BC-2500

**MODULAR SWITCH MODE UTILITY  
BATTERY CHARGER / POWER SUPPLY**

## **USER'S MANUAL**

---

*Important Safety,  
Installation,  
Operation, and  
Maintenance  
Instructions*

---



**EAGLE EYE**  
POWER SOLUTIONS

---

## TABLE OF CONTENTS

<b>IMPORTANT SAFETY INSTRUCTIONS</b> .....	<b>3</b>
<b>1. INTRODUCTION</b> .....	<b>5</b>
<b>2. THEORY OF OPERATION</b> .....	<b>6</b>
<b>3. RECEIVING AND INSTALLING THE CHARGER</b> .....	<b>6</b>
<b>4. AC INPUT</b> .....	<b>11</b>
<b>5. DC OUTPUT</b> .....	<b>11</b>
<b>6. BATTERY TEMPERATURE SENSOR</b> .....	<b>12</b>
<b>7. USER INTERFACES</b> .....	<b>13</b>
7.1. User Interface Module (UIM) .....	13
7.2. Front Panel LEDs .....	14
7.3. Digital Meter .....	15
7.4. Ground Fault Detection (GFD) (130Vdc and 48Vdc Only) .....	15
7.5. GFD ON/OFF Switch (130Vdc and 48Vdc only) .....	15
<b>8. CHARGER OPERATION</b> .....	<b>15</b>
<b>9. LED INDICATORS</b> .....	<b>16</b>
9.1. Front Panel and UIM LEDs .....	16
9.2. iPM Bi-Color LED .....	17
<b>10. ETHERNET COMMUNICATION</b> .....	<b>18</b>
10.1. Direct Local Communication .....	18
10.2. Networked Remote or Local Communication .....	18
10.3. Manual (Static) Mode .....	18
10.4. Changing the Ethernet Port Settings .....	21
10.5. Automatic (DHCP) Mode .....	22
10.6. Restoring the Factory-Default Ethernet Port Settings .....	23
<b>11. WEB SERVER</b> .....	<b>24</b>
11.1. Dashboard .....	24
11.2. Configuration >> System Settings .....	28
11.3. Configuration >> Charge Settings .....	29
11.4. Configuration >> Alarm Settings .....	32
11.5. Configuration >> Date and Time Settings .....	34
11.6. Configuration >> Ethernet Settings >> Ethernet Port .....	34
11.7. Configuration >> Ethernet Settings >> SNMP .....	36
11.8. Configuration >> User Accounts .....	36
11.9. Configuration >> Upgrades .....	38
11.10. History .....	39
11.11. Logout .....	46
<b>12. MAINTENANCE</b> .....	<b>46</b>
12.1. Check the Area Around the Charger .....	46
12.2. Physical Cleaning .....	46
12.3. Visual Inspection .....	47
<b>13. TROUBLESHOOTING AND SERVICING</b> .....	<b>47</b>
13.1. Charger Troubleshooting Chart .....	48
13.2. UIM Replacement Information .....	51
13.3. Service Parts List .....	52
<b>14. CHARGER WIRE DIAGRAMS</b> .....	<b>54</b>
<b>15. SPECIFICATIONS</b> .....	<b>57</b>

---

## **IMPORTANT SAFETY INSTRUCTIONS**

1. **SAVE THESE INSTRUCTIONS** – This manual contains important safety and operating instructions. Keep it in a location where it is available to anyone who may operate the charger.
2. Before using battery charger, read all instructions and cautionary markings on battery charger, battery, and product using battery.



**LOOK FOR THIS SYMBOL TO POINT OUT SAFETY PRECAUTIONS. IT MEANS: *BE ALERT—YOUR SAFETY IS INVOLVED.* IF YOU DO NOT FOLLOW THESE SAFETY INSTRUCTIONS, INJURY OR PROPERTY DAMAGE CAN OCCUR.**

3. **⚠ DANGER:** TO REDUCE THE RISK OF FIRE OR ELECTRIC SHOCK, CAREFULLY READ AND FOLLOW THESE IMPORTANT SAFETY AND OPERATING INSTRUCTIONS BEFORE INSTALLING OR OPERATING THE CHARGER.
4. **⚠ INSTRUCTIONS IMPORTANTES CONCERNANT LA SECURITÉ.**
5. **⚠ WARNING:** TO REDUCE THE RISK OF FIRE, INSTALL THIS BATTERY CHARGER ON A SURFACE OF NON-COMBUSTIBLE MATERIAL.
6. **⚠ DANGER:** RISK OF ELECTRIC SHOCK. DISCONNECT CHARGER FROM BATTERY AND AC POWER BEFORE SERVICING. TURNING OFF THE CHARGER DOES NOT REDUCE THIS RISK.
7. **⚠ DANGER:** RISK OF ELECTRIC SHOCK. DO NOT TOUCH UNINSULATED PORTION OF AC OR DC CONNECTORS OR UNINSULATED BATTERY TERMINAL.
8. **⚠ DANGER:** RISQUE DE CHOCKS ÉLECTRIQUES. NE PAS TOUCHER LES PARTIES NON ISOLÉES DU CONNECTEUR DE SORTI OU LES BORNES NON ISOLÉES DE L'ACCUMULATEUR.
9. **⚠ CAUTION:** CHARGE ONLY BATTERIES OF THE SAME TYPE, VOLTAGE, CELL NUMBER, AND AMP-HOUR CAPACITIES AS THE CHARGER IS DESIGNED FOR. OTHER TYPES OF BATTERIES MAY BURST CAUSING PERSONAL INJURY AND DAMAGE. BEFORE CHARGING ANY OTHER TYPE OF RECHARGEABLE BATTERY, CHANGE THE CHARGER CONFIGURATION/SETTINGS AS RECOMMENDED BY THAT BATTERY MANUFACTURER.
10. **⚠ ATTENTION:** UTILISER POUR CHARGER UNIQUEMENT LES ACCUMULATEURS AU PLOMB À ELECTROLYTE LIQUIDE. D'AUTRES TYPES D'ACCUMULATEURS POURRAIENT ÉCLATER ET CAUSER DES.
11. **⚠ DANGER:** TO PREVENT ELECTRICAL SHOCK, DO NOT TOUCH EITHER AC OR DC UNINSULATED PARTS. MAKE SURE ALL ELECTRICAL CONNECTORS ARE IN GOOD WORKING CONDITION. DO NOT USE CONNECTORS THAT ARE CRACKED, CORRODED OR DO NOT MAKE ADEQUATE ELECTRICAL CONTACT. USE OF A DAMAGED OR DEFECTIVE CONNECTOR MAY RESULT IN A RISK OF OVERHEATING OR ELECTRIC SHOCK.
12. **⚠ WARNING:** HAZARD OF ELECTRIC SHOCK.

- 
13. **⚠ WARNING: BATTERIES GENERATE EXPLOSIVE GASES. TO PREVENT ARCING OR BURNING NEAR BATTERIES, DO NOT DISCONNECT DC CHARGING OUTPUT FROM BATTERIES WHEN THE CHARGER IS OPERATING. KEEP SPARKS, FLAME, AND SMOKING MATERIALS AWAY FROM BATTERIES.**
  14. **⚠ WARNING: ALWAYS SHIELD EYES WHEN WORKING NEAR BATTERIES. DO NOT PUT WRENCHES OR OTHER METAL OBJECTS ACROSS BATTERY TERMINAL OR BATTERY TOP. ARCING OR EXPLOSION OF THE BATTERY CAN RESULT.**
  15. **⚠ WARNING: BATTERIES PRODUCE HYDROGEN GAS, WHICH CAN EXPLODE IF IGNITED. NEVER SMOKE, USE AN OPEN FLAME, OR CREATE SPARKS NEAR THE BATTERY. VENTILATE THE AREA WHEN THE BATTERY IS CHARGING IN AN ENCLOSED PLACE.**
  16. **⚠ WARNING: BATTERIES CONTAIN CAUSTIC MATERIAL, WHICH MAY CAUSE BURNS. DO NOT GET IN EYES, ON SKIN, OR CLOTHING. IF CONTACT WITH THE EYES OCCURS, FLUSH IMMEDIATELY WITH CLEAN WATER FOR 15 MINUTES AND OBTAIN MEDICAL ATTENTION.**
  17. **⚠ WARNING: DE-ENERGIZE ALL AC AND DC POWER CONNECTIONS BEFORE SERVICING THIS UNIT. IF INJURY DOES OCCUR, APPLY STANDARD TREATMENT FOR ELECTRICAL SHOCK AND, IF NECESSARY, CONSULT WITH A PHYSICIAN.**
  18. **⚠ WARNING: THE CHARGER IS NOT FOR OUTDOOR USE. DO NOT EXPOSE THE CHARGER TO RAIN OR SNOW.**
  19. **⚠ CAUTION: DO NOT OPERATE THE CHARGER IF IT HAS RECEIVED A SHARP BLOW, BEEN DROPPED, OR OTHERWISE DAMAGED. HAVE A QUALIFIED SERVICE TECHNICIAN EXAMINE AND REPAIR AS NEEDED.**
  20. **⚠ WARNING: DO NOT DISASSEMBLE THE CHARGER. HAVE THE CHARGER EXAMINED BY A QUALIFIED SERVICE AGENT. INCORRECT RE-ASSEMBLY OF THE CHARGER MAY RESULT IN AN EXPLOSION, ELECTRIC SHOCK, OR FIRE.**
  21. **⚠ CAUTION: MAKE SURE THE BATTERY SYSTEM HAS THE PROPERLY RATED VOLTAGE, AMP-HOURS, AND TYPE FOR THIS CHARGING SYSTEM.**

## **SAVE THESE INSTRUCTIONS**

This equipment has been tested and found to comply with the limits for a Class A digital device, pursuant to part 15 of the FCC Rules. These limits are designed to provide reasonable protection against harmful interference when the equipment is operated in a commercial environment. This equipment generates, uses and can radiate radio frequency energy and, if not installed and used in accordance with the instruction manual, may cause harmful interference to radio communications. Operation of this equipment in a residential area is likely to cause harmful interference in which case the user will be required to correct the interference at his own expense.

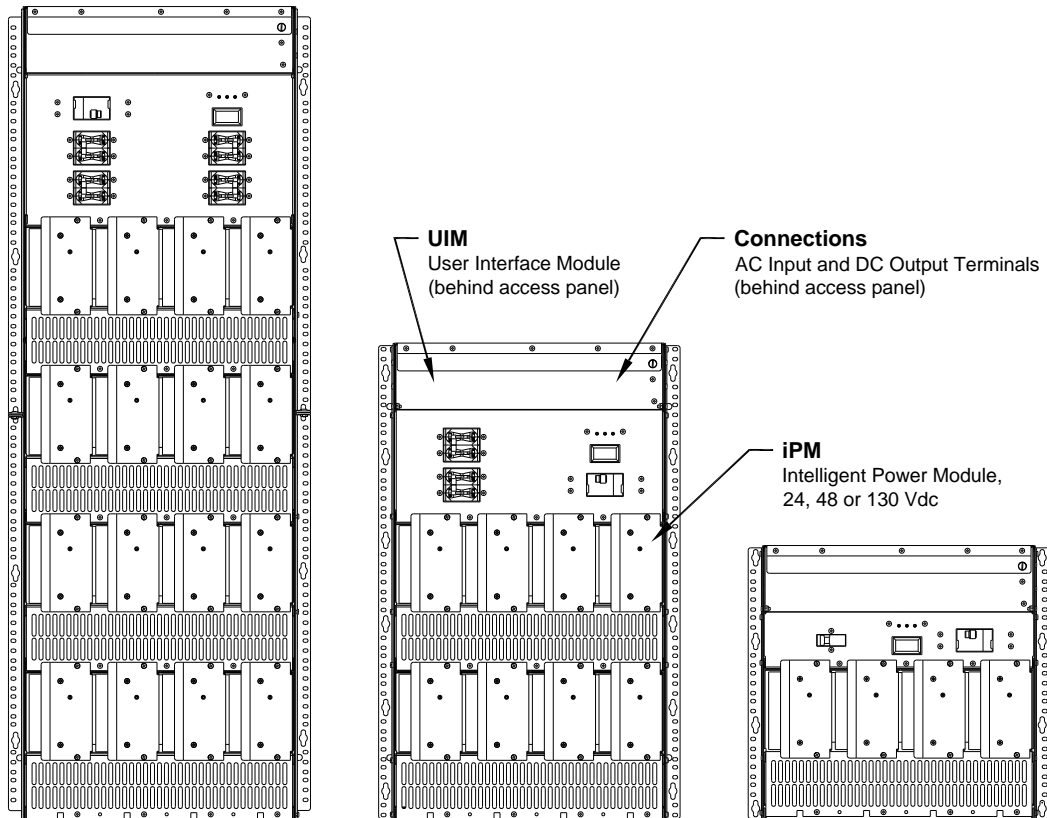
## 1. INTRODUCTION

The Eagle Eye BC-2500 is a modular switch mode (high frequency) battery charger / power supply platform designed for railroad signal and communication, as well as other stationary / reserve power applications.

BC-2500 is convection cooled with no fans or other moving parts and designed to provide maximum reliability in industrial environments. The modular architecture provides redundancy and maximizes uptime, and the system controller combines the simplicity of rotary switches to adjust the float voltage with sophisticated communication, alarming, and logging options. The universal AC input enables the charger to be used with a wide range of AC voltages and frequencies, and the system features high energy efficiency and power factor.

Optional communication modules may be added to the unit including an 8-channel Alarm Relay Module, Modbus RS-232, and Modbus RS-485. Contact your nearest Eagle Eye service agent at 1-877-805-3377 for more information.

As is illustrated in Figure 1-1, a BC-2500 system includes a chassis. The chassis has an access panel near the top for access to the User Interface Module (UIM) that serves as the system controller and for access to the AC input and DC output terminals. Chassis are available with four (4), eight (8), or sixteen (16) [130V models only] slots for Intelligent Power Modules (iPMs).



**Figure 1-1: BC-2500 System Components**

24Vdc-400W-10A, 48Vdc-480W-10A and 130Vdc-480W-4A iPMs are available. See Figure 1-2 for the maximum system DC output current for a given number of iPMs. A BC-2500 system can be set to charge batteries within a voltage range of 10-40 volts (24Vdc nominal system), 30-61 volts (48Vdc nominal system), or 100-150 volts (130Vdc nominal system) for nickel-cadmium (Ni-Cd), valve regulated lead-acid (VRLA), and flooded/vented lead-acid (FLA) batteries. The values shown throughout this manual in the instruction tables and figures are for generic use and may be different from the actual values programmed in your unit. Customized settings are available, contact your nearest Eagle Eye service agent at 1-877-805-3377.

Number of iPMs	Maximum System DC Output Current (A)		
	24Vdc iPMs	48Vdc iPMs	130Vdc iPMs
1	10	10	4
2	20	20	8
3	30	30	12
4	40	40	16
5	50	50	20
6	60	60	24
7	70	70	28
8	80	80	32
9	-----	-----	36
10	-----	-----	40
11	-----	-----	44
12	-----	-----	48
13	-----	-----	52
14	-----	-----	56
15	-----	-----	60
16	-----	-----	64

**Figure 1-2: Number of iPMs and the Corresponding Maximum System DC Output Current**

## 2. THEORY OF OPERATION

The charger has an "IE" profile which is (1) a constant-current bulk/start phase followed by (b) a constant-voltage float phase. When the charger is first started, if the battery pack voltage is below the charger float voltage value, it will output a constant current in the bulk phase. The constant current value is controlled by the "Max DC Output Current" setting available via the charger web server using the Ethernet port.

When the battery pack nears the charger float voltage value, the charger will transition from the bulk phase into the float phase. The output current will decrease to maintain a constant float voltage. The charger float voltage value is controlled by either (1) the "NUMBER OF CELLS" and "VOLTS PER CELL" rotary switches on the UIM or (2), if the "NUMBER OF CELLS" rotary switches are set to "00", the "Number of Cells" and "Float Voltage Per Cell" settings available via the charger web server control the float voltage value (see Section 11.3 for value ranges). The constant float voltage will be maintained indefinitely to keep the battery pack fully charged.

The charger web server, which is detailed in Section 11, includes other settings, such as battery temperature compensation, that can be adjusted per the requirements of the battery pack and overall system.

## 3. RECEIVING AND INSTALLING THE CHARGER

**⚠ WARNING: NEVER PLACE ANYTHING ON TOP OF THE CHARGER WHILE OPERATING. DAMAGE TO THE CHARGER OR BATTERIES COULD OCCUR.**

**⚠ WARNING: THE CHARGER MUST BE SET UP FOR THE PROPER USER SPECIFICATIONS BEFORE STARTING THE INITIAL CHARGE.**

**⚠ WARNING: CHARGERS CAN IGNITE FLAMMABLE MATERIALS AND VAPORS. DO NOT USE NEAR FUELS, GRAIN DUST, SOLVENTS, THINNERS, OR OTHER FLAMMABLES.**

**⚠ WARNING: REPLACE WORN, DAMAGED, OR CUT ELECTRICAL CORDS AND CONNECTORS IMMEDIATELY.**

Proper installation of the charger is important to achieve good charger performance and to prevent damage to the charger and batteries.

When a charger is received, a check for possible in-transit damage should be made. If any damage is found, it should be reported as a claim to the carrier.

---

The dimensions for the chargers and mounting brackets are shown in Figure 3-1 (8-slot chassis), Figure 3-2 (4-slot chassis), and Figure 3-3 (16-slot chassis).

To permit free air flow for convention cooling, allow 2 inches (51 mm) minimum between the charger sides and other equipment and 4 inches (102 mm) minimum on top of the charger. Do not mount the charger above other heat generating equipment.

The charger can be mounted on a shelf, countertop, floor, wall, or rack. The charger includes adjustable mounting brackets that provide highly flexible mounting options. See Figure 3-1 (8-slot chassis), Figure 3-2 (4-slot chassis), or Figure 3-3 (16-slot chassis) for details.

### **Wall Mounting**

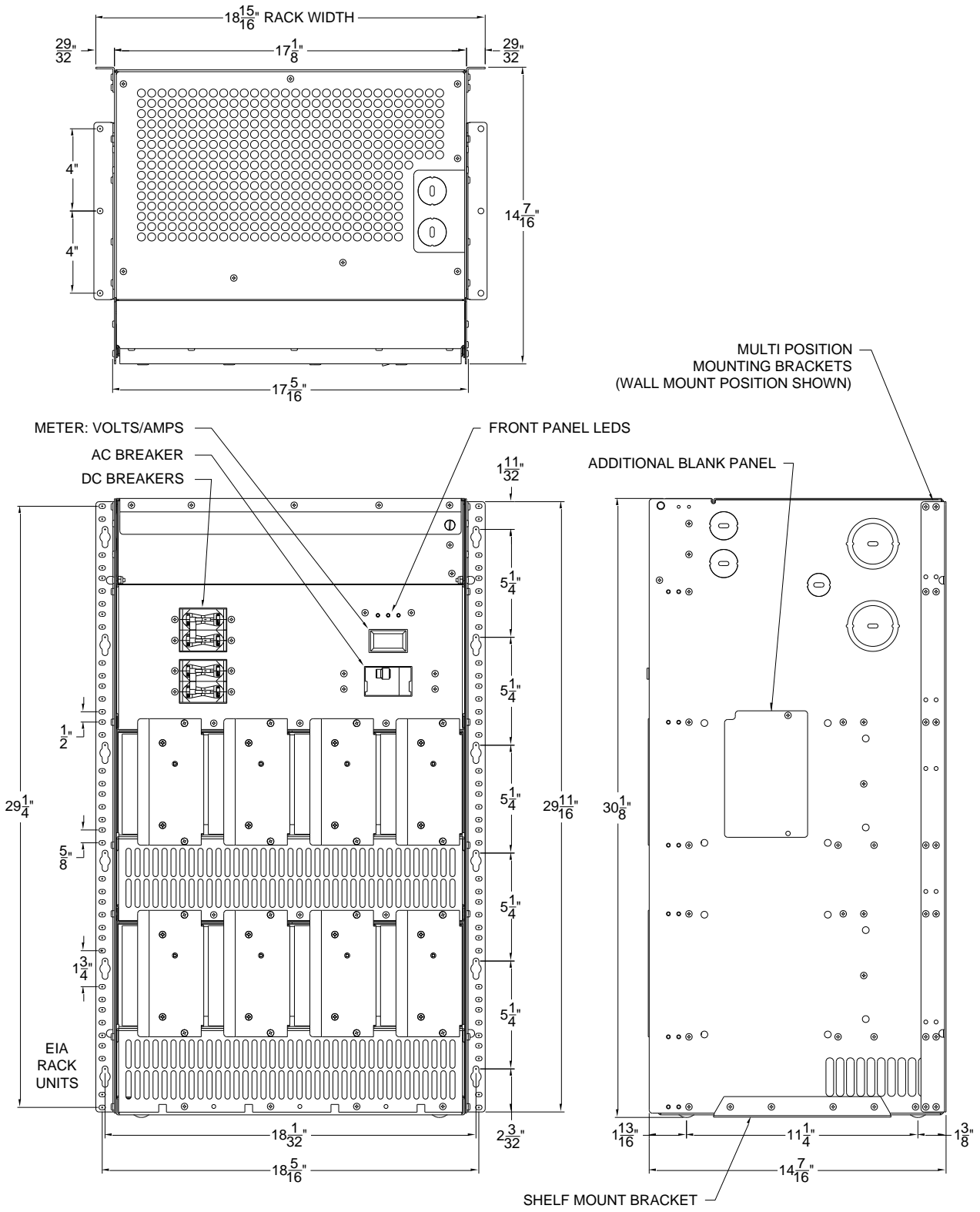
The charger can be fastened to a wall for mounting by attaching the mounting brackets to the last two rows of side mounting screw holes near the rear of the charger as shown in Figure 3-1 (brackets are factory installed for wall mounting). For a 16-slot chassis use a minimum of twelve (six per side), 8-slot chassis use a minimum of eight (four per side), or for a 4-slot chassis use a minimum of six (three per side) of a 1/4 x 2 inch minimum length bolt or lag screw with washer installed in the key slots uniformly distributed on the mounting brackets.

### **Shelf Mounting**

The charger can be fastened to a shelf for mounting by attaching a bracket to the bottom row of holes on the sides of the charger using four screws in each bracket as shown in Figure 3-1 (all chassis have these brackets factory installed for shipping purposes). For all chassis use a minimum of six (three per side) of a 1/4 x 1-1/2 inch minimum length bolt or lag screw with washer installed in the bottom mounting brackets.

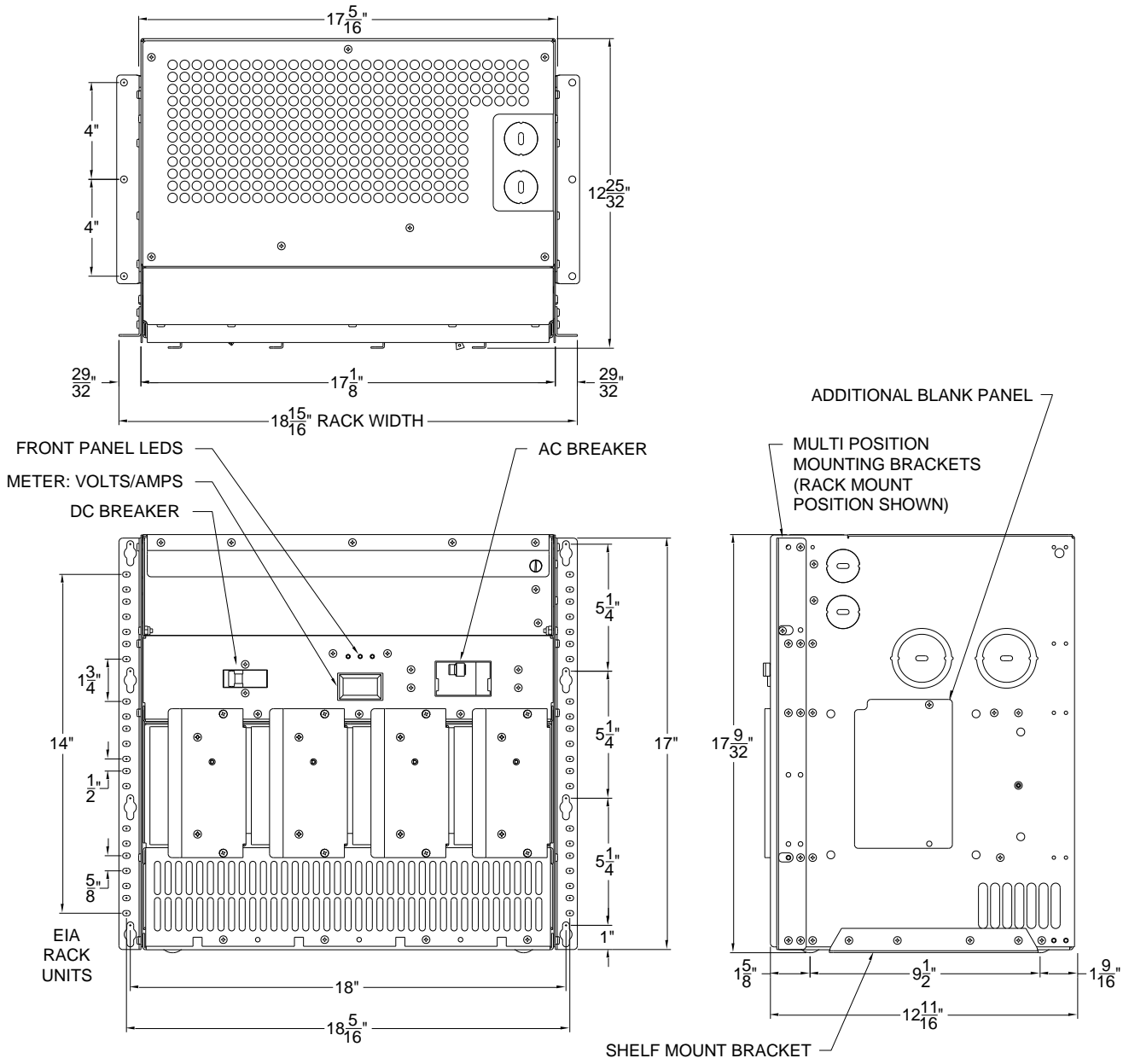
### **Rack Mounting**

The 4, 8, and 16 slot chassis can be mounted to a standard Electronic Industries Association (EIA) 19" (483mm) rack system. An industry standard 3/8" square hole rack using 12-24 UNC cage nuts and 12-24 UNC rack screws are recommended (six per side for 16-slot, five per side for 8-slot, and four per side for 4-slot chassis units). The mounting brackets will need to be moved from the rear to the front of the unit as shown in Figure 3.2. Use the same screws to attach the brackets to the front row of holes on each side of the unit. A 12-24 screw should be installed through one of the two highest slots and one of the two lowest 0.218" X 0.312" slots in both of the two mounting brackets with the rest of the screws uniformly distributed along the height of the bracket. The 12-24 screws should be tightened to 40 in-lb. If other sizes and/or types of fasteners are used, the quantity, location and tightening torque should be designed as recommended by the rack manufacturer to be at least as strong as the above recommendation.

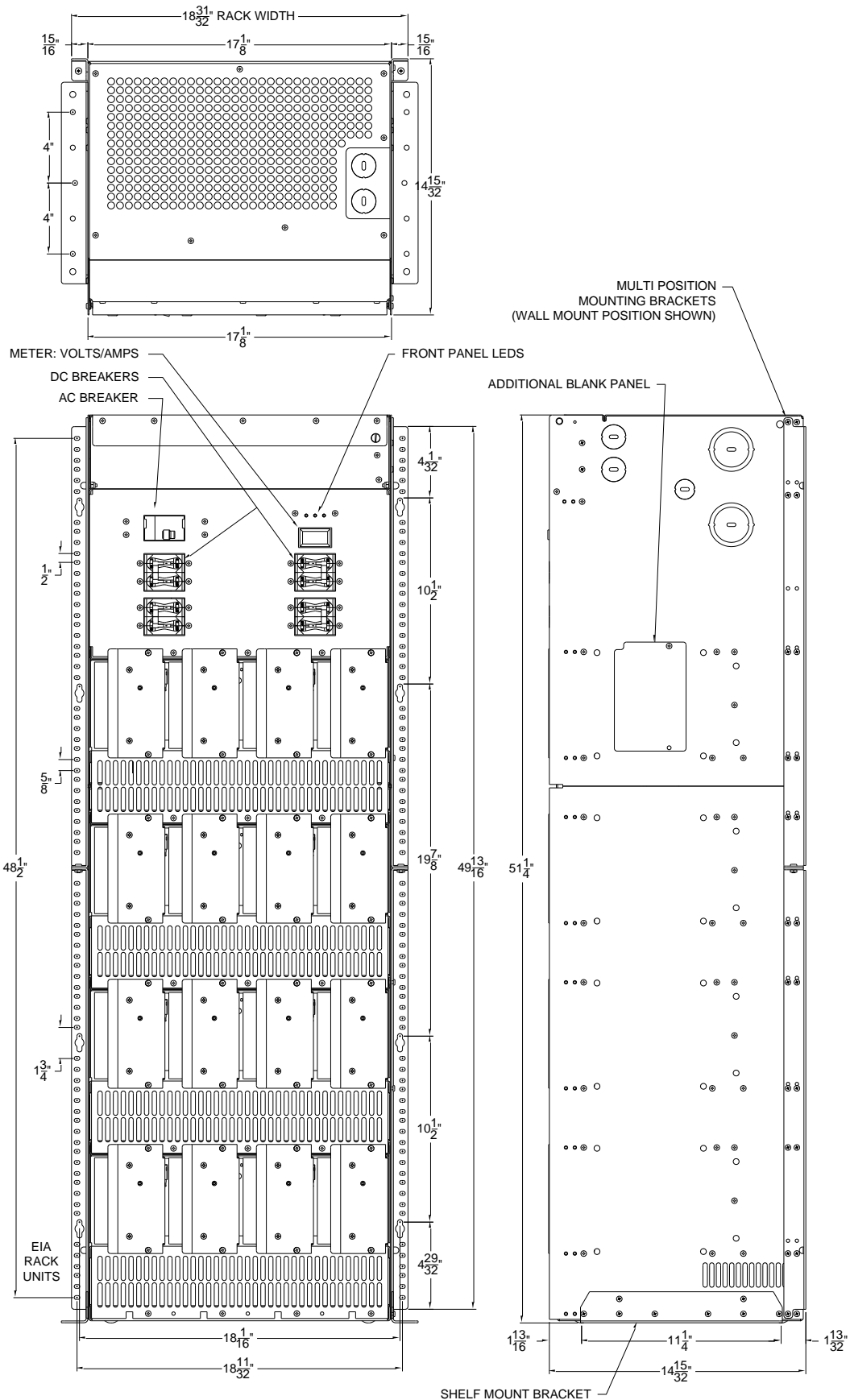


**Figure 3-1: Dimensions for 8-Slot Chassis and Mounting Brackets**





**Figure 3-2: Dimensions for 4-Slot Chassis and Mounting Brackets**



**Figure 3-3: Dimensions for 16-Slot Chassis and Mounting Brackets**

---

## 4. AC INPUT

**⚠ WARNING: FAILURE TO PROPERLY CONNECT THE AC VOLTAGE CONDUCTORS COULD CAUSE SERIOUS DAMAGE TO THE CHARGER.**

**⚠ WARNING: DO NOT OPERATE THE CHARGER WITHOUT PROPER GROUNDING. IMPROPER GROUNDING CAN RESULT IN THE RISK OF AN ELECTRIC SHOCK.**

**⚠ CAUTION: TO REDUCE THE RISK OF ELECTRIC SHOCK OR FIRE, DISCONNECT AC POWER FROM THE CHARGER BEFORE INSTALLING OR REMOVING UNIT.**

**⚠ WARNING: DO NOT TOUCH THE CHARGER'S TERMINALS OR AN ELECTRICAL SHOCK COULD OCCUR. A VOLTAGE IS PRESENT ON THE DC TERMINALS EVEN AFTER THE AC IS DISCONNECTED BECAUSE OF THE ENERGY STORED IN THE CAPACITORS.**

All 4-slot and 8-slot chargers have an AC input rating of 100-240 volts, 50-200 hertz, single-phase with an AC operating range of 90-264 volts, 45-205 hertz. Below 100 volts, the charger may reduce output power.

The 16-slot charger (130V only) has an AC input rating of 208-240 volts, 50-200 hertz, single-phase with an AC operating range from 190-264 volts, 45-205 hertz.

Use an appropriate size wire for the AC input and strip back the insulation 13/32 inches (0.406). Maximum wire size is 4AWG for the AC and DC terminal block located behind the access panel. Open the access door cover on the front of the charger. The charger has several knockouts that can be used to route the AC wires to the terminal block. Per your application, remove the selected knockout and route the AC wires and/or conduit in accordance with the National Electrical Code and all local codes and ordinances. **Dress field installed Class 2 or Class 3 circuits at least 1/4 inch (6.3 mm) away from power, light, or Class 1 circuits.** Connect the AC ground to the terminal lug provided, as marked on the inside of the access panel and torque to 35 in-lbs (3.95 N-m). Connect the AC input wires to the two top connection points of the terminal block as marked on the terminal block decal. Torque the AC terminal block connections to 20 in-lbs.

## 5. DC OUTPUT

**⚠ WARNING: DO NOT TOUCH THE CHARGER'S TERMINALS OR AN ELECTRICAL SHOCK COULD OCCUR.**

**⚠ WARNING: BATTERIES GENERATE EXPLOSIVE GAS. CHARGE ONLY IN WELL VENTILATED AREAS. TO PREVENT ARCING OR BURNING NEAR BATTERIES, DO NOT DISCONNECT THE DC CHARGING CONNECTOR(S) FROM THE BATTERIES WHEN THE CHARGER IS OPERATING. IF THE CHARGE CYCLE MUST BE INTERRUPTED, TURN OFF THE AC TO THE UNIT OR SWITCH THE CHARGER'S INPUT AND OUTPUT CIRCUIT BREAKERS TO THE OFF POSITION BEFORE DISCONNECTING THE DC OUTPUT CONNECTOR(S) FROM THE BATTERIES. KEEP SPARKS, FLAME, AND SMOKING MATERIALS AWAY FROM BATTERIES. TO REDUCE THE RISK OF FIRE, DO NOT USE THE CHARGER NEAR FLAMMABLE MATERIALS OR VAPORS.**

Use Table 5-1 to select the appropriate size and length DC output battery cable for your application. Maximum wire size is 4AWG for the AC and DC terminal block. The charger has several knockouts that can be used to route the DC battery cables to the terminal block. Per your application, remove the selected knockout and route the DC battery cables and/or conduit in accordance with the National Electrical Code and all local codes and ordinances. **Dress field installed Class 2 or Class 3 circuits at least 1/4 inch (6.3 mm) away from power, light, or Class 1 circuits.**

To attach the DC output cable to the DC terminal block, strip back the insulation 13/32 inches (10.3 mm). Connect the two DC battery cables to the bottom two connection points of the terminal block using the polarity as marked on the terminal block decal. Torque the DC terminal block connections to 20 in-lbs (2.26Nm). Make sure the polarity of the DC battery cables is the same as those connected to the battery. The charger will not operate in a reversed polarity condition. If the DC polarity is reversed, the main DC output circuit breaker will protect the charger from internal damage. Correct the reversed wires and reset the circuit breaker. Close the access door after tightening the DC cable connections.

Maximum DC Cord Length per Wire Gauge			
Wire Size (AWG)	Rated Voltage / Chassis size	Max Output Current in Amps	Maximum Length in Feet (Charger to Battery)
14	130V / 4-slot	16	11
12	130V / 8-slot	32	9
	130V / 4-slot	16	18
10	130V / 8-slot	32	13
	130V / 4-slot	16	26
	48V / 4-slot, 24V / 4-slot	40	10
8	130V / 16-slot	64	11
	130V / 8-slot	32	22
	130V / 4-slot	16	44
	48V / 4-slot, 24V / 4-slot	40	18
6	130V / 16-slot	64	18
	130V / 8-slot	32	36
	130V / 4-slot	16	72
	48V / 8-slot, 24V / 8-slot	80	15
	48V / 4-slot, 24V / 4-slot	40	30
4	130V / 16-slot	64	29
	130V / 8-slot	32	58
	130V / 4-slot	16	116*
	48V / 8-slot, 24V / 8-slot	80	23
	48V / 4-slot, 24V / 4-slot	40	46

\* Over DC Cable Length settings limit

**Table 5-1: Maximum DC Cordset Length**

## 6. BATTERY TEMPERATURE SENSOR



**WARNING: IT IS IMPORTANT TO MOUNT THE TEMPERATURE SENSOR ON THE BATTERIES FOR PROPER TEMPERATURE COMPENSATION.**

The external battery temperature sensor is an optional way of extending battery life by using temperature compensation. One end of the temperature sensor cable has a three-pin plug that plugs into a connector labeled "BATTERY TEMP SENSOR" on the UIM (see Figure 7.1-1). The other end of the cable has the temperature sensor sealed in a ring terminal.

---

The terminal-type sensor should be attached to a negative (-) battery post near the center of the battery pack. If the threaded stud is long enough above the battery jumper nut, attach the sensor with another nut. Torque this nut to proper specifications. If the stud is too short, the nut holding the jumper wire will need to be removed. Open or remove the load and charging circuits to the batteries. Remove the nut holding the jumper and add the sensor, then torque the nut to the proper specifications. Then close or connect the load and charging circuits back to the batteries.

**Securely fasten the temperature sensor cable to protect the sensor from being torn from the battery.** Secure the sensor cable to a fixed object to ensure the sensor will not be pulled loose. Use a cable tie mount on the battery or on the adjacent battery, if necessary.

## 7. USER INTERFACES

### 7.1. User Interface Module (UIM)

The UIM is the unit's system controller and is located behind the front access panel. Below are descriptions of the user interface items found on the UIM. Figure 7.1-1 identifies these user interface items.

#### **Number of Cells Rotary Switches**

Used to manually set the number of battery cells. See Section 11.3 for value ranges. Setting to "00" enables control via the web server.

#### **Volts Per Cell Rotary Switches**

Used to manually set the float voltage per cell. See Section 11.3 for value ranges. Not used if the "NUMBER OF CELLS" rotary switches are set to "00", which enables float voltage control via the web server.

#### **UIM Status LED**

Green LED. See the UIM LEDs table for possible states.

#### **Alarm LED**

Red LED. See the UIM LEDs table for possible states.

#### **AC Present LED**

Green LED that is on when AC power is present.

#### **Confirm Local Presence Button and LED**

Pressing the button enables setting/alarm changes to be saved via the web server for a set amount of time. This ensures that the changes are being made locally and provides the highest level of possible security. **Note:** A valid user must be logged into the web server for the local presence button to be enabled. If the LED goes out immediately after pressing the local presence button, the user is not logged in.

#### **Alarm Relay Terminals**

Form C, dry contacts. Configurable per alarm via the web server by selecting the K1 relay in the alarm settings menu.

#### **Relay Terminal Remote Wiring**

The terminal strip has OPEN, COMMON, and CLOSED relay contacts for remote wiring. COMMON to CLOSED has continuity when no alarms or faults for the K1 relay are active. To insert a 28 to 12 AWG wire striped 5 to 6mm, use a small screw driver to push the white tab at the top upwards. Insert the wire and verify good contact. The relay contacts are rated for 1A at 30Vdc or 0.5A at 120Vac.

#### **Battery Temperature Sensor Connector**

Can be connected to a battery temperature sensor to temperature compensate the charge profile. Enabled/disabled, compensation value, min compensation limit, and max compensation limit configurable via the web server. The reference temperature for compensation is 25°C or 77°F.

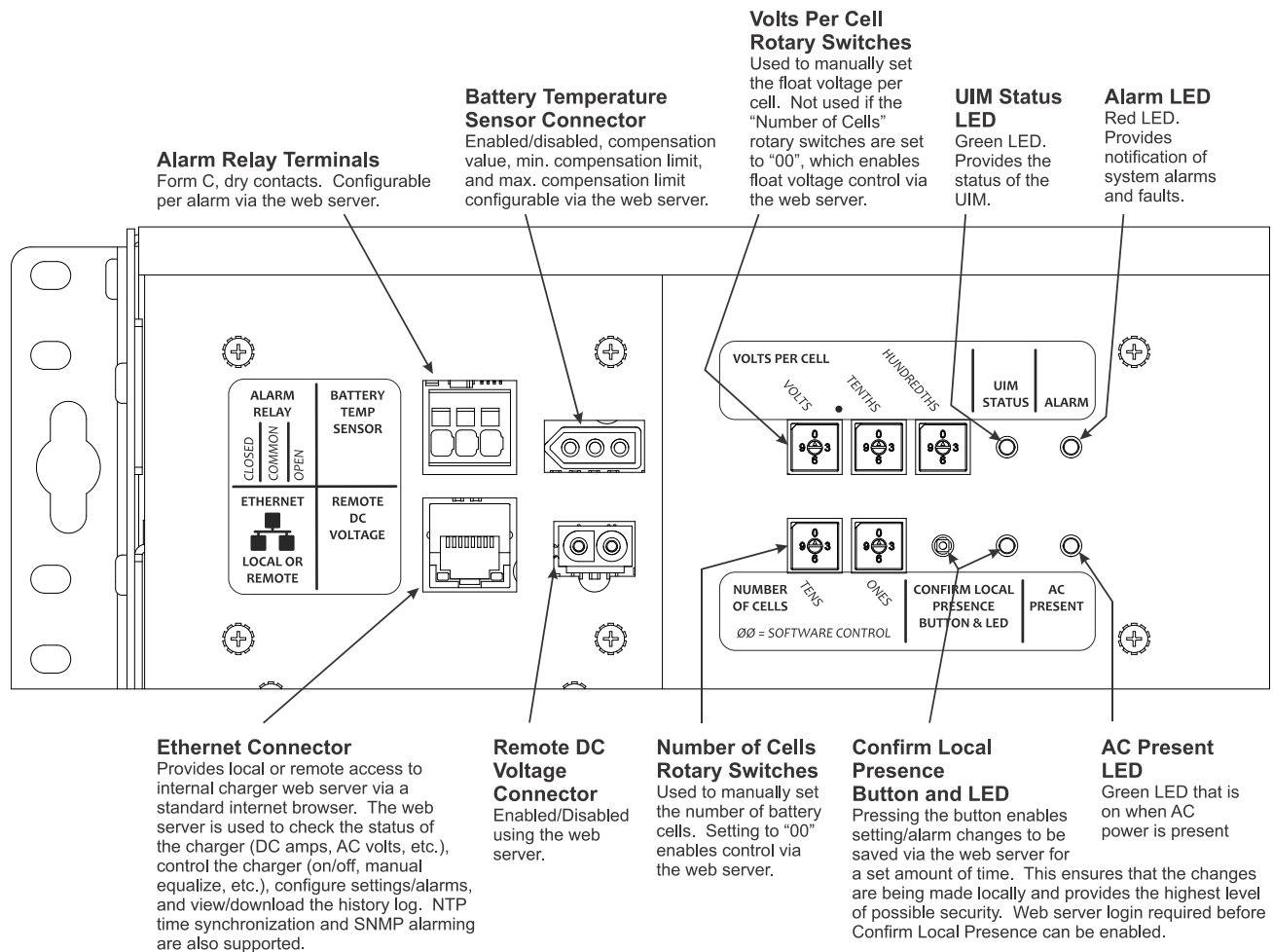
## Ethernet Connector

Provides local or remote access to the internal charger web server via a standard Internet browser. The web server is used to check the status of the charger (DC amps, AC volts, etc.), control the charger (on/off, manual equalize, etc.), configure settings/alerts, and view/download the history log. NTP time synchronization and SNMP alarming are also supported.

## Remote DC Voltage Connector

Can be wired directly to the battery pack to measure the voltage without any DC cable drop. Enabled/disabled via the web server. This option allows for a more accurate float voltage at higher current levels.

The UIM is powered by both AC and DC power so it will remain powered on when AC power is lost. This allows all alarms and the UIM to function as desired. Removal of both the AC and DC power and then return of either power source will allow for the UIM LEDs to do a power up sequence and reboot the UIM.



**Figure 7.1-1: User Interface Items on the UIM**

## 7.2. Front Panel LEDs

The UIM also drives three LEDs located on the front panel of the unit to indicate basic functionality. These LEDs duplicate the functionality of the "UIM Status LED", "Alarm LED", and "AC present LED" as explained above and illustrated in Figure 7.2-1.

### 7.3. Digital Meter

A multi-function digital meter is located on the front of the unit. The meter will display both the system voltage and current. The voltage is the top number displayed in red which is internal to the unit and may not be the same voltage seen by the battery due to cord loss. The bottom green number displays the output current of the charger, so depending on the application, the batteries and load may share this current. Figure 7.2-1 illustrates the meter.

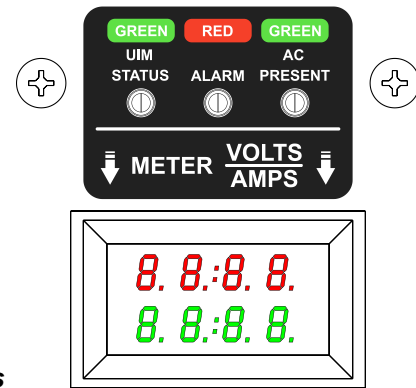


Figure 7.2-1: Front Panel LEDs

### 7.4. Ground Fault Detection (GFD) (130Vdc and 48Vdc Only)

Ground Fault Detection (GFD) is standard with 130Vdc and 48Vdc models and is not available on 24Vdc models. The GFD module monitors the current levels between both [1] DC positive (+) and ground and [2] DC negative (-) and ground and, if the “Ground Fault Detection” alarm is enabled in the charger web server, generates an alarm if either current level meets the trigger level set in the charger web server. See Section 11.4 for additional information regarding configuring alarms via the charger web server.

**Only one GFD device should be present in a DC system. With multiple GFD devices, one or more of the devices could alarm due to the presence of the other devices.**

### 7.5. GFD ON/OFF Switch (130Vdc and 48Vdc only)

Located inside the access door below the UIM, the GFD ON/OFF switch is standard on 130Vdc and 48Vdc models. The GFD ON/OFF switch is intended to be used to disable the charger GFD circuit when manual ground fault measurements will be taken. With the switch in the ON position, the charger GFD circuit is enabled. When performing manual ground fault measurements externally from positive (+) or negative (-) DC to ground with the charger GFD circuit enabled, the voltage readings will be approximately 1/2 of the battery voltage. Switching the GFD ON/OFF switch to the OFF position disables the charger GFD circuit, which enables manual ground fault measurements to show actual leakage to ground.

**With the GFD ON/OFF switch in the OFF position, both the DC positive (+) and DC negative (-) sense leads are disconnected, so the GFD circuit is completely disconnected from DC. If a ground fault occurs, it will not be sensed by the charger. The charger web server may still show the “Ground Fault Detection” alarm as enabled, but it will never be triggered. If charger GFD is desired, ensure that the GFD ON/OFF switch is returned to the ON position after manual ground fault measurements have been completed.**

## 8. CHARGER OPERATION

**⚠️ WARNING: TO REDUCE THE RISK OF AN ELECTRIC SHOCK, CONNECT ONLY TO A SINGLE-PHASE, PROPERLY GROUNDED (3-WIRE) AC SOURCE. REFER TO GROUNDING INSTRUCTIONS.**

**⚠️ CAUTION: MAKE SURE THE BATTERY IS A RECHARGEABLE BATTERY WITH THE PROPER RATED VOLTAGE FOR THIS CHARGER.**

**⚠️ DANGER: TO PREVENT ELECTRICAL SHOCK, DO NOT TOUCH UNINSULATED PARTS OF THE CHARGER AC INPUT OR DC OUTPUT TERMINALS, AC INPUT OR DC OUTPUT WIRING, OR BATTERY TERMINALS. MAKE SURE ALL ELECTRICAL CONNECTORS ARE IN GOOD WORKING CONDITION. DO NOT USE CONNECTORS THAT ARE CRACKED, CORRODED, OR DO NOT MAKE ADEQUATE ELECTRICAL CONTACT. USE OF A DAMAGED OR DEFECTIVE CONNECTOR MAY RESULT IN A RISK OF OVERHEATING OR ELECTRIC SHOCK.**

**⚠ WARNING: BATTERIES GENERATE GASES WHICH CAN BE EXPLOSIVE. TO PREVENT ARCING OR BURNING NEAR BATTERIES, DO NOT DISCONNECT THE CHARGER DC OUTPUT FROM THE BATTERIES WHEN THE CHARGER IS OPERATING. KEEP SPARKS, FLAME, AND SMOKING MATERIALS AWAY FROM BATTERIES.**

**⚠ WARNING: ALWAYS SHIELD EYES WHEN WORKING NEAR BATTERIES. DO NOT PUT WRENCHES OR OTHER METAL OBJECTS ACROSS THE BATTERY TERMINALS OR THE BATTERY TOP. ARCING OR EXPLOSION OF THE BATTERY CAN RESULT!**

**⚠ WARNING: DO NOT DISCONNECT THE CHARGER DC OUTPUT FROM THE DC WIRING WHILE A CHARGE CYCLE IS IN PROGRESS. THE RESULTING ARCING AND BURNING COULD CAUSE THE BATTERIES TO EXPLODE.**

- Check the “NUMBER OF CELLS” and “VOLTS PER CELL” rotary switches on the UIM to verify their settings against the specifications of the batteries (see Section 11.3 for value ranges). If the “NUMBER OF CELLS” rotary switches are set to “00”, which enables software control of the float voltage value, refer to Section 11.3 to verify the “Number of Cells” and “Float Voltage Per Cell” setting values via the charger web server (see Section 11.3 for value ranges).
- The float voltage should be set to the battery manufacturer’s specified voltage at 25 °C (77 °F).
- Refer to Section 11 to verify other charger web server settings, such as the battery temperature compensation values.
- When AC input power is applied and the AC and DC circuit breakers are in the ON position, the DC output will start after a short delay unless the UIM Output Control has been turned off.
- The bi-color LED on the iPM(s) provides DC output status information along with iPM fault status information. It also specifies where in the charge profile the system currently resides (start/bulk, float, or equalize). See Section 9.2 for details.
- To stop the charger, turn off the AC input power to the unit, switch the AC and DC breakers to the OFF position, or use the “Output Control” button available on the charger web server “Dashboard” (see Section 11.1).

## 9. LED INDICATORS

### 9.1. Front Panel and UIM LEDs

The table below outlines the functionality of the front panel and UIM LEDs. See Figures 7.1-1 and 7.2-1 as a reference to the location of the LEDs on the front panel and on the UIM. The "Confirm Local Presence" LED is only located on the UIM.

	AC PRESENT	UIM STATUS	CONFIRM LOCAL PRESENCE	ALARM	Description
	Green	Green	White	Red	
AC Input Power	Off				AC input power is not present.
	Solid				AC input power is present.
Power Up	Solid / Off	Solid / Off	Solid / Off	Solid / Off	LEDs turn on and then off independently on power up as an LED test.
UIM Status		Off			UIM is not functioning properly or the external alarm relay box has failed.
		Solid			UIM and external relay alarm box (if so equipped) is functioning properly.



Confirm Local Presence			Off	Confirm Local Presence (CLP) timer is not active. Web server changes cannot be saved. CLP button must be pressed to activate the CLP timer.
			Solid	Confirm Local Presence (CLP) timer is active. Web server changes can be saved.
Alarms & Faults			Off	No alarms or faults are active.
			Solid	At least one alarm is active with a priority of "Major" or "Minor". Alarms configured with a priority of "Warning" do not activate the "Alarm" LED.

## 9.2. iPM Bi-Color LED

The table below outlines the functionality of the iPM bi-color LED. When both green and red LEDs are on, the color appears amber.

	iPM Bi-Color LED			Description
	Green	Red	Amber	
Power Up	Solid / Off	Solid / Off		LEDs turn on and then off independently on power up as an LED test.
DC Output Status	Off			DC output is off. Either (1) AC input power is not present, (2) the output has been manually turned off via the UIM web server, or (3) the systems "Power Saving Mode" has been enabled and the iPM is not currently active (other iPMs in the system are still active). Note: Later software iPMs will have a green slow blink every 5 seconds for conditions 2 or 3.
	Slow Blink			* DC output is in constant-current bulk/start mode.
	Solid			DC output is in constant-voltage float mode.
Alarms & Faults		Solid		An iPM fault is active. DC output is off.
		Slow Blink		The iPM is unable to communicate with the UIM, so the iPM is operating using the last configuration it received from the UIM before communication ceased.
		Fast Blink		DC output is off due to a limit being exceeded (max iPM temperature, etc). The DC output will turn back on when the limit is no longer being exceeded.
Equalizing or Test Modes			Slow Blink	DC output is in equalize mode. The charger output is in constant-current bulk/start mode while equalize mode is active.
			Solid	DC output is in equalize mode, Continuity test, or Battery Load test. The charger output is in constant-voltage float mode while one of these modes is active.

\* If slow blink is once every 5 seconds the iPM is either shut down or in power saving mode.

---

## 10. ETHERNET COMMUNICATION

The Ethernet port is located on the UIM (see Figure 7.1-1). It can be used to locally or remotely communicate with the internal charger web server via a direct local connection to a laptop computer accessed via a standard Internet browser or a networked connection to a remote or local laptop or desktop computer, smart phone, or tablet via a standard Internet browser. **Enable JavaScript within the Internet browser you plan to use per the browser instructions (JavaScript is typically enabled by default). The Internet browser must also support HTML5, which all popular modern browsers do (Internet Explorer is not recommended) .**

The Ethernet port can also be connected to an optional communication module which allows you to remotely monitor the battery charger over a serial connection which supports Modbus protocols over RS-232 or RS-485. Contact your nearest Eagle Eye service agent at 1-877-805-3377 for more information.

### 10.1. Direct Local Communication

The charger Ethernet port is not auto crossover, or auto MDI-X. A crossover Ethernet cable may be required to connect to a local laptop computer if the computer is not auto crossover capable. See Section 10.3 for Manual (Static) Mode configuration instructions for direct local communication. The charger can then be accessed via a standard Internet browser.

### 10.2. Networked Remote or Local Communication

The charger Ethernet port can be connected to an Ethernet switch or router via a standard Ethernet cable to add the charger to a network. See Section 10.3 for Manual (Static) Mode configuration instructions for networked communication. See Section 10.4 for Automatic (DHCP) Mode configuration instructions for networked communication. Once the charger has been added to a network, it can be accessed via a remote or local laptop computer, desktop computer, smart phone, or tablet via a standard Internet browser.

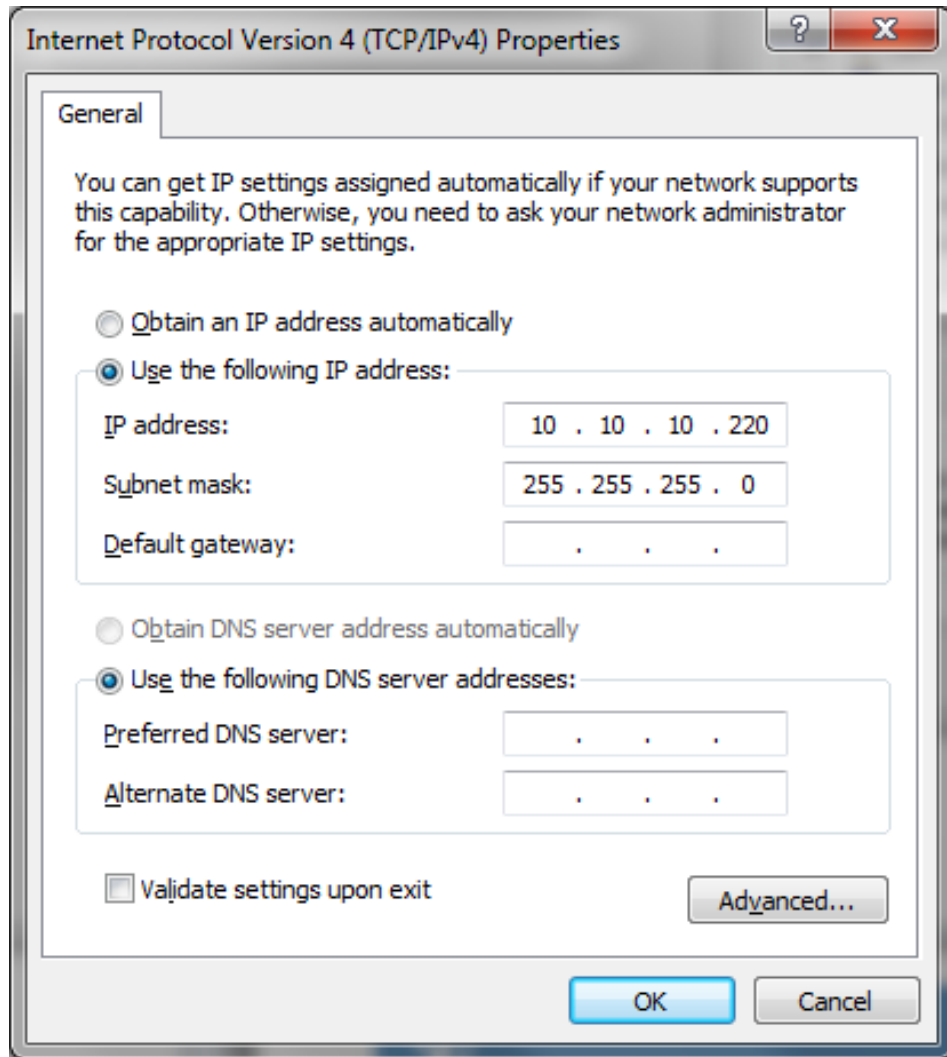
### 10.3. Manual (Static) Mode

The charger generic settings from the factory is “Manual (Static) Mode” with an “IP Address” of “10.10.10.210” and a “Subnet Mask” of “255.255.255.0”.

#### Direct Local Communication

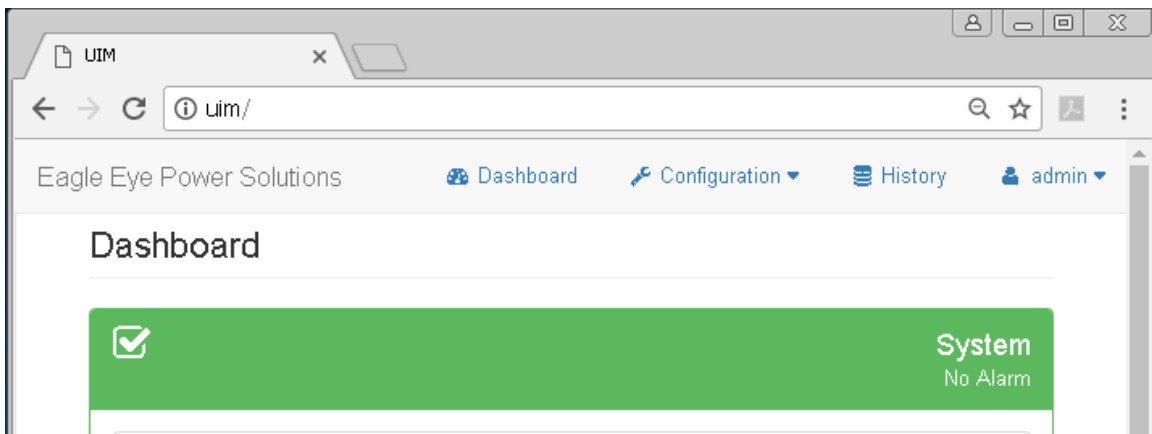
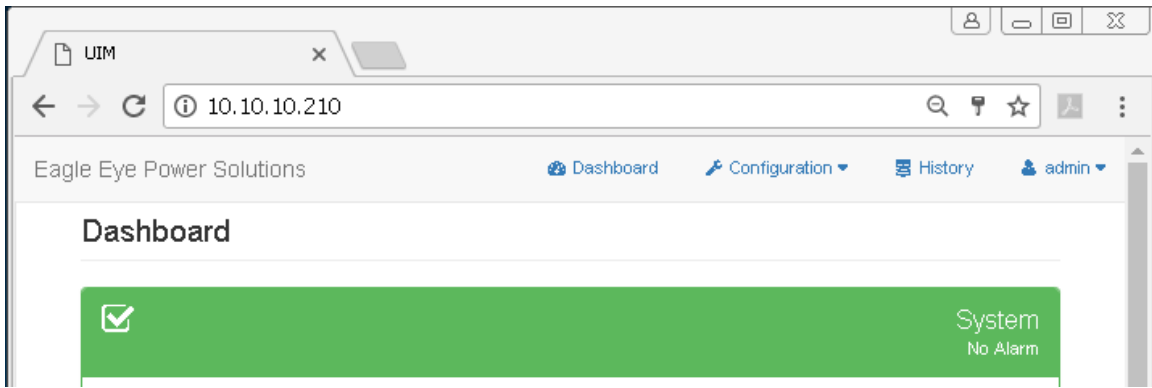
To establish direct local communication with a laptop computer, after connecting the charger Ethernet port to the laptop Ethernet port, follow the steps below on a laptop computer. (The steps below are for Windows 7 and 10. If you are using a different version of Windows or a different operating system, the steps will vary).

- Navigate to:
  - Start >> Control Panel (View by: Category) >> Network and Internet >> Network and Sharing Center >> Change Adapter Settings
  - OR-
  - Start >> Control Panel (View by: Large Icons or View by: Small Icons) >> Network and Sharing Center >> Change Adapter Settings
- Right-click on “Local Area Connection” and select “Properties”
- Select “Internet Protocol Version 4 (TCP/IPv4)” and click the “Properties” button
- Select “Use the following IP address:”
- Enter an “IP address:” of “10.10.10.XXX”, where “XXX” is any 3-digit number other than “210” (for example, “10.10.10.220”)
- Enter a “Subnet mask:” of “255.255.255.0”
- Press the “OK” button



**Figure 10.3-1: Laptop Computer Ethernet Port Settings – Manual (Static) Mode**

- Open an Internet browser (Windows Internet Explorer, Google Chrome, etc) and enter “10.10.10.210” or “uim” in the address bar as shown in Figures 10.3-2 and 10.3-3. Note: If Internet Explorer is used it must be version 10 or higher.
- When the Login box pops up, login to the webserver. After login, if setting changes are required then press the Confirm Local Presence Button on the charger.
- When login in, if a message of “All user slots were allocated.” appears on the login box, this indicates another user is currently logged into the webserver. Only one user is allowed at a time. A refresh of the webpage after the other user has logged out will allow a new login.



**Figure 10.3-2: Accessing the Internal Charger Web Server via a Standard Internet Browser**

A screenshot of a login form. At the top, there is a header with a right-pointing arrow icon and the text 'Login'. Below this, there are two input fields. The first is labeled 'Username:' and contains the text 'admin'. The second is labeled 'Password:' and contains masked characters represented by six dots. Below the password field, there is a red error message that reads 'All user slots were allocated.'. At the bottom of the form, there is a large blue button with the text 'Log in'.

**Figure 10.3-3: All User Slots are Allocated**


---

## 10.4. Changing the Ethernet Port Settings

The “Ethernet Port” section on the “Configuration >> Ethernet Settings” page is shown in Figure 10.4-1. The following settings can be viewed and/or changed per your direct or networked communication requirements.

- Physical Address
  - This is the MAC address of the charger Ethernet port, which is read-only
- Address Mode
  - “Manual (Static)” (see Section 10.3) or “Automatic (DHCP)” (see Section 10.5)
- UIM Network Name
- This allows more than one charger to be addressed on the same network. (15 characters maximum IP Address
- Subnet Mask
- Gateway Address
- Primary DNS Address
- Secondary DNS Address
- Web Page Refresh Rate
  - This value was hard coded on previous software (SW) versions and could not be changed. The latest version SW allows changes for networking improvements. (500msec was the old default value and now it is changeable up to 5000msec). Note: Changing this to a value higher than 500msec will cause the Web page refresh rate to be noticeably slower and can confuse the user to think it is not communicating with the UIM.
- CLP Button Refresh Rate
  - This value was hard coded on previous SW versions and could not be changed. The latest version SW allows changes for networking improvements. (500msec was the old default value and now it is changeable up to 5000msec). Note: Changing this to a value higher than 500msec may cause the “Press CLP button” message to momentarily appear even though it is pressed.
- SNMP Heartbeat Refresh Rate (hours)
  - This parameter allows a SNMP heartbeat to be periodically sent for communication verification to the enabled SNMP destinations IP addresses. The UIM serial number and firmware version traps are the information sent when this is active. Setting this value to zero (0) disables the heartbeat message.

---

 Ethernet Port

Physical Address  
68-27-19-2B-97-84

Address Mode  
Manual (Static) ▼

UIM Network Name  
UIM

IP Address  
10.10.10.210

Subnet Mask  
255.255.255.0

Gateway Address  
0.0.0.0

Primary DNS Address  
0.0.0.0

Secondary DNS Address  
0.0.0.0

Web Page Refresh Rate  
500 ms ▼

CLP Button Refresh Rate  
500 ms ▼

SNMP Heartbeat Refresh Rate (hours)  
0

Update

**Figure 10.4-1: Ethernet Port Section of the Configuration >> Ethernet Settings Page**

## 10.5. Automatic (DHCP) Mode

When the charger is being connected to a network, it will often need to be configured for Automatic (DHCP) Mode. In order to do so, first follow the instructions in Section 10.3 to directly connect a laptop or desktop computer to the charger. Then, navigate to the “Ethernet Port” section on the “Configuration >> Ethernet Settings” page and change the “Address Mode” setting value to “Automatic (DHCP)”, as shown in Figure 10.5-1.

The screenshot shows the 'Ethernet Port' configuration page. At the top, there is a network icon and the title 'Ethernet Port'. Below this, several configuration fields are listed:

- Physical Address:** 68-27-19-2B-97-84
- Address Mode:** Automatic (DHCP) (selected in a dropdown menu)
- UIM Network Name:** UIM
- IP Address:** 10.10.10.210
- Subnet Mask:** 255.255.255.0
- Gateway Address:** 0.0.0.0
- Primary DNS Address:** 0.0.0.0
- Secondary DNS Address:** 0.0.0.0
- Web Page Refresh Rate:** 500 ms (selected in a dropdown menu)
- CLP Button Refresh Rate:** 500 ms (selected in a dropdown menu)
- SNMP Heartbeat Refresh Rate (hours):** 0

At the bottom of the form is a large blue button labeled 'Update'.

**Figure 10.5-1: Ethernet Port Section of the Configuration >> Ethernet Settings Page – Automatic (DHCP) Mode**

## 10.6. Restoring the Factory-Default Ethernet Port Settings

If you are unable to communicate with a charger after changing the settings within the “Ethernet Port” section on the “Configuration >> Ethernet Settings” page, you can restore the factory-default “Ethernet Port” settings by following the steps below

- Remove AC and DC (battery) power from the charger.
- Press and hold the “CONFIRM LOCAL PRESENCE” button on charger UIM.
- Re-apply AC and or DC (battery) power to the charger while continuing to hold the “CONFIRM LOCAL PRESENCE” button until the charger completes booting up (UIM LED startup sequence has finished.).
- The “Ethernet Port” settings have now been restored to the factory-defaults.
- Follow the steps in Section 10.3 again.

---

## 11. WEB SERVER

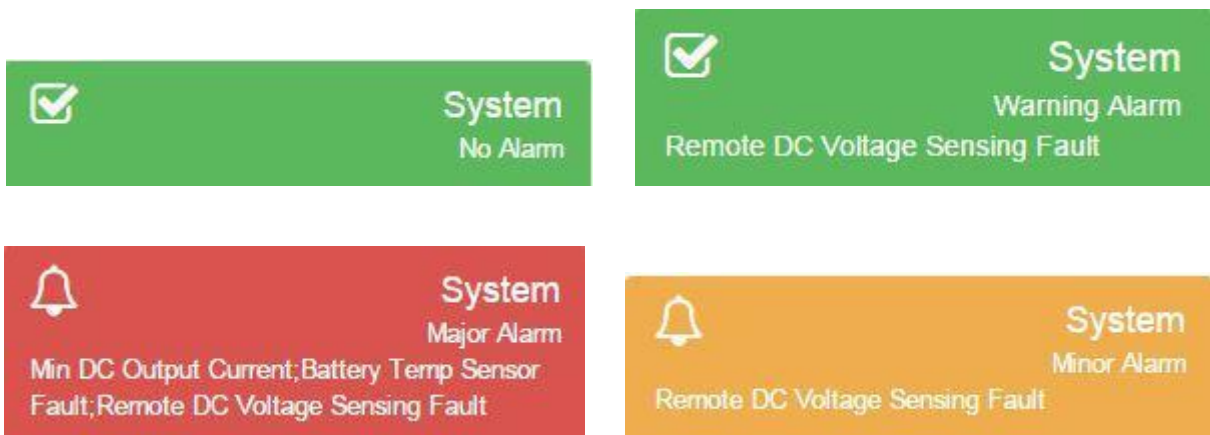
The internal charger web server can be accessed via a standard Internet browser on a local or remote laptop or desktop computer, smart phone, or tablet. See Section 10 for connectivity instructions.

Web server changes can only be made after the "CONFIRM LOCAL PRESENCE" button has been physically pressed on the UIM. Pressing this button starts a timer. After this time has expired, the "CONFIRM LOCAL PRESENCE" button must be pressed again to make additional web server changes.

### 11.1. Dashboard

#### System

The header for the "System" section on the "Dashboard" page displays the system alarm status as is illustrated in Figure 11.1-1.



**Figure 11.1-1: System Section Header on the Dashboard Page Displays the System Alarm Status**

Below are descriptions of the items displayed in the "System" section of the "Dashboard" page.

Name	Description
Site Name	"Site Name" setting value on the web server "Configuration >> System Settings" page.
Serial Number	Serial number of the chassis/UIM.
UIM Firmware	Firmware version on the UIM.
Webserver Firmware	Firmware version of the web server on the UIM.
Battery Voltage	DC voltage at end of DC cable or the remote battery sense cable.
DC Output Current	Total DC output current of the system.
DC Output Power	Total DC output power of the system.
AC Input Voltage	AC input voltage.



Battery Temperature	<p>Battery pack temperature.</p> <p>If the "Remote Battery Temperature" setting on the web server "Configuration &gt;&gt; System Settings" page is enabled then the Battery Temperature will be displayed if no temperature sensor faults.</p> <p>If the battery temperature sensor is disconnected or has failed, then "Fault" will be displayed.</p> <p>If the "Remote Battery Temperature" setting on the web server "Configuration &gt;&gt; System Settings" page is disabled, then "Disabled" is displayed.</p>
Internal Charger Temperature	Internal charger temperature at the UIM.
Float Voltage Controlled By	<p>Location of float voltage control.</p> <p><u>Rotary Switches</u>: rotary switches on the UIM.</p> <p><u>Web</u>: settings on the web server "Configuration &gt;&gt; Charge Settings" page in the "Charge Profile" section.</p>
DC Voltage Sensing	<p>Location of the DC voltage sensing.</p> <p><u>Local</u>: charger DC output terminals at the end of the DC cable. This is dependent on proper output cord settings. See if the web server "Systems Settings" page to setup "DC Cable Gauge" and "DC Cable Length".</p> <p><u>Remote</u>: "REMOTE DC VOLTAGE" input on the UIM. This will be displayed if the "Remote Battery Voltage" setting on the web server "Configuration &gt;&gt; System Settings" page is enabled and sensed properly.</p> <p>Configured via the "Remote Battery Voltage" setting on the web server "Configuration &gt;&gt; System Settings" page.</p> <p>Local (Remote Fault): This will be displayed if the "Remote Battery Voltage" setting on the web server "Configuration &gt;&gt; System Settings" page is enabled but not sensed for some reason.</p>
Confirmed Local Presence Time Remaining	The amount of time remaining in minutes that web server changes can be made. After this time has expired, the "CONFIRM LOCAL PRESENCE" button on the UIM must be pressed again to make additional web server changes.

### **iPMs**

Below are the items displayed in the "iPMs" section of the "Dashboard" page for each active iPM in the system.

- Slot ID
- Model
- Serial Number
- Firmware
- Current
- Power

---

## **Manual Control**

The “Output Control” Action button in the “Manual Control” section of the “Dashboard” page can be used to manually turn the charger output off and on. The “Current State” column in the table lets you know if the charger output is currently in the on or off state (see Figure 11.1-2).

The “Start Manual Equalize Charge” Action button in the “Manual Control” section of the “Dashboard” page can be used to manually start or stop an equalize charge cycle. The “Current State” column in the table lets you know if an equalize charge cycle is currently in progress (see Figure 11.1-2).

The equalize voltage per cell for the battery pack is defined by the “Equalize Voltage Per Cell” setting value in the “Charge Profile” section on the “Configuration >> Charge Settings” page. The duration in minutes of the equalize charge cycle is defined by the “Equalize Time” setting value in the “Charge Profile” section on the “Configuration >> Charge Settings” page. See Section 11.3 for details regarding these settings. An Automatic Equalize charge cycle will start when the Equalize Interval timer has been met unless a Manual Battery Load Test or Continuity Test is in process. If one of these is in process, then the interval timer is paused and will be restarted after completion of the testing. The Equalize Interval time is reset each time the Equalize time has been met or if equalize is manually stopped and an Equalize Performed event is added to the Event records.

The “Start Manual Continuity Test” Action button in the “Manual Control” section of the “Dashboard” page can be used to manually start or stop a continuity test. The “Current State” column in the table lets you know if a continuity test is currently in progress (see Figure 11.1-2).

The Continuity test can be manually started using this button or set to automatically activate once every 1 to 255 days. The following settings are necessary to perform a test: Continuity/Battery Load Test Voltage per Cell and Continuity Test Interval if automatic is selected. When the Continuity Test Interval value has been met, the enabled Continuity Test will drop the charger voltage set point to the Continuity/Battery Load Test Voltage per Cell level for approximately 15 seconds and the iPM LEDs will go to the Amber color during this time. The webserver dashboard display will show “Now Testing” for this. During this test time the equalize and battery load action buttons are disabled. If the charger UIM measures a voltage level equal to or less than the Continuity Fault/Battery Load alarm trigger level plus 0.05 volts per cell, then the test will continue with approximately 3 minutes of normal float voltage level (no temperature compensation), then drop down for 15 seconds again to the continuity test voltage level a second time. iPM LEDs are amber only during the 15 second test time indicating this process. If the voltage measured this second time is equal to or less than the Continuity Fault/Battery Load alarm trigger level plus 0.05 volts per cell, then a Continuity fault will be flagged and recorded on the dashboard and in the Event Records.

The “Start Manual Battery Load Test” Action button in the “Manual Control” section of the “Dashboard” page can be used to manually start or stop a battery load test. The “Current State” column in the table lets you know if a battery load test is currently in progress (see Figure 11.1-2).

The battery load test requires setting the Continuity/Battery Load Test Voltage per Cell level and the Continuity Fault/Battery Load alarm trigger. When the Battery Load Test is activated, the float voltage is lowered to the Continuity/Battery Load Test Voltage per Cell level and a timer begins until the battery voltage drops to the Continuity Fault/Battery Load alarm trigger setting. When the trigger level is reached, the Battery Load Test is terminated, the battery load time is recorded in the history event records, and the charger returns to the normal float level. The iPM LEDs will go to the Amber color during the Battery Load Test. Based on the time and the battery load, estimated battery amp-hours can be calculated to determine the battery condition and expected life.

### **Manual Control Priority list from highest to lowest priority:**

- 1) Output Control: Output OFF
- 2) Start Manual Battery Load Test
- 3) Start Manual Continuity Test
- 4) Start Manual Equalize Charge

Manual Control		
Name	Current State	Action
Output Control	Output ON	Turn Output OFF
Start Manual Equalize Charge	NOT Equalizing	START EQ Charge
Start Manual Continuity Test	NOT Testing	START Test
Start Manual Battery Load Test	NOT Testing	START Test

Manual Control		
Name	Current State	Action
Output Control	Output ON	Turn Output OFF
Start Manual Equalize Charge	NOT Equalizing	START EQ Charge

Figure 11.1-2: Manual Control Section of the Dashboard Page

Manual Control		
Name	Current State	Action
Output Control	Output ON	Turn Output OFF
Start Manual Equalize Charge	NOW Equalizing	STOP EQ Charge
Start Manual Continuity Test	NOT Testing	START Test
Start Manual Battery Load Test	NOT Testing	START Test

Figure 11.1-3: Dashboard Showing Equalizing

## 11.2. Configuration >> System Settings

Name	Units	Values	Notes
Site Name	None	30 characters (including spaces)	The "Site Name" is displayed on the web server "Dashboard" page in the "System" section.
Number of iPMs (Rectifiers)	None	1-4 (4-slot chassis) 1-8 (8-slot chassis) 1-16 (16-slot chassis)	Select the number of iPMs installed in the chassis. This setting is used to detect "iPM Communication Lost" faults and the maximum DC output current allowed for the charger system.
Nominal DC Output Voltage	V	24, 48, or 130	Read-only setting is automatically selected based on the DC output voltage of the initial iPM installed in an empty chassis. This setting is used to detect "iPM Incorrect DC Voltage" faults if an iPM of the incorrect voltage is inserted into the chassis.
DC Cable Gauge	AWG	0-14	Used for DC cable compensation to automatically adjust the DC output voltage to compensate for voltage drop across the DC cables when the Remote Battery Voltage option is not being used. This must be set properly for the cable that is used for local voltage sense to work properly.
DC Cable Length	ft	1-100	Enter the DC cable length between the charger output terminals and the battery pack in a single direction only. Used for DC cable compensation to automatically adjust the DC output voltage to compensate for voltage drop across the DC cables when the Remote Battery Voltage option is not being used. This must be set properly for the cable that is used for local voltage sense to work properly.
Remote Battery Temperature	None	Disabled or Enabled	"Enabled" must be selected to use the "BATTERY TEMP SENSOR" input on the UIM connected to a battery temperature sensor to measure the temperature of the battery pack.  The "Temperature Compensation (TC)" setting must be enabled on the web server "Configuration >> Charger Profile" page for the charge profile to be temperature compensated.
Remote Battery Voltage	None	Disabled or Enabled	"Enabled" must be selected to use the "REMOTE DC VOLTAGE" input on the UIM to sense the DC voltage at the end of the Remote Battery Sense cable that is connected to the battery instead of the cable drop adjust voltage at the battery terminals.
Temperature Units	None	°C or °F	The selected temperature units are used throughout the web server.
Start Delay	minutes	0-1440	When AC input power is applied to the charger, the start of the charge cycle will be delayed by

			this number of minutes. <b>THIS FEATURE IS CURRENTLY NOT ACTIVE.</b>
Power Saving Mode	None	Disabled or Enabled	When "Enabled" is selected, the minimum number of iPMs will be on to source the required DC output current. When "Disabled" is selected, the iPMs are all on and will evenly source the DC output current.
Confirm Local Presence Time	minutes	1-20	The amount of time in minutes that web server changes can be made after the "CONFIRM LOCAL PRESENCE" button has been physically pressed on the UIM. After this time has expired, the "Confirm Local Presence" button must be pressed again to make additional web server changes.
Manual-Off Auto Override Time	Minutes	0-240	The amount of time in minutes before the DC output is turned back on after it was shut off using the manual off button on the dashboard. If set to zero, the feature is disabled and the output will stay off until manually turned back on. Note: If this feature is activated (non-zero) and the battery voltage has dropped to a level below the voltage trigger level, the output will automatically turn back on. This trigger level is 0.02 volts per cell above the alarm setting for Battery voltage low.
Equalize on AC Power Up	None	Disabled or Enabled	When "Enabled" is selected, this feature uses the Charger Settings equalize parameters Equalize Volts per Cell and Equalize Time. For this feature to be triggered, the battery voltage must be high enough for the UIM to remain powered up when AC Power is applied but be below the Battery Voltage Low alarm setting.

### 11.3. Configuration >> Charge Settings

#### Charge Profile

Name	Units	Values	Notes
Float Voltage Per Cell	V	<u>24V (10.00-40.00Vdc)</u>  Lead-Acid: 10 cells: 1.00-3.00 11 cells: 1.00-3.00 12 cells: 1.00-3.00  Ni-Cd: 18 cells: 1.00-2.22 19 cells: 1.00-2.10 20 cells: 1.00-2.00  <u>48V (30.00-61.00Vdc)</u>  Lead-Acid: 20 cells: 1.50-3.00 21 cells: 1.43-2.90 22 cells: 1.37-2.77	The float voltage per cell for the battery pack. Disabled (grayed out) when the "NUMBER OF CELLS" rotary switches on the UIM are set to anything other than "00".  Setting Limits = 1.00 - 3.00

		<p>23 cells: 1.31-2.65  24 cells: 1.25-2.54  Ni-Cd:  36 cells: 1.00-1.69  37 cells: 1.00-1.64  38 cells: 1.00-1.60  39 cells: 1.00-1.56  40 cells: 1.00-1.52</p> <p><u>130V (100.00-150.00Vdc)</u></p> <p>Lead-Acid:  54 cells: 1.86-2.77  55 cells: 1.82-2.72  56 cells: 1.79-2.67  57 cells: 1.76-2.63  58 cells: 1.73-2.58  59 cells: 1.70-2.54  60 cells: 1.67-2.50  Ni-Cd:  92 cells: 1.09-1.63  93 cells: 1.08-1.61  94 cells: 1.07-1.59  95 cells: 1.06-1.57  96 cells: 1.05-1.56  97 cells: 1.04-1.54  98 cells: 1.03-1.53</p> <p>* Contact an Eagle Eye representative regarding other configurations.</p>	
Number of Cells	cells	<p><u>24V (10.00-40.00Vdc)</u>  Cells: 5 - 26</p> <p><u>48V (30.00-61.00Vdc)</u>  Cells: 14 - 42</p> <p><u>130V (100.00-150.00Vdc)</u>  Cells: 35 - 99</p> <p>* Contact an Eagle Eye representative regarding other configurations.</p>	<p>The number of cells in the battery pack. Disabled (grayed out) when the "NUMBER OF CELLS" rotary switches on the UIM are set to anything other than "00".</p> <p>24V Setting Limits = 5 - 26  48V Setting Limits = 14 - 42  130V Setting Limits = 35 - 99</p>
Max DC Output Current  Maximum settable value changes with number of valid iPMs per chassis	A	<p><u>24V &amp; 48V</u>  10.0A per iPM</p> <p><u>130V</u>  4.0A per iPM</p>	<p>Used to limit the DC output current. This setting is the total system DC output current.</p>
Automatic Equalize	None	Disabled or Enabled	<p>When "Enabled" is selected, automatic equalization charge cycles occur using the settings below.</p>

Equalize Interval	Days	1-365	The interval in days for automatic equalize charge cycles to occur. For example, entering a value of "90" would trigger an automatic equalize charger cycle every 90 days.
Equalize Voltage Per Cell	V	1.00-3.00	The equalize voltage per cell for the battery pack.  This setting is also used when the "Start Manual Equalize Charge" button is pressed on the web server "Dashboard" page in the "Manual Control" section.
Equalize Time	minutes	1-10080	The duration in minutes of the equalize charge cycle.  This setting is also used when the "Start Manual Equalize Charge" button is pressed on the web server "Dashboard" page in the "Manual Control" section.
Temperature Compensation (TC)	None	Disabled or Enabled	When "Enabled" is selected, temperature compensation of the charge cycle occurs using the settings below.
TC Min Temperature Adjust	°C or °F	-40 to 70°C or -40 to 158°F	Below this temperature, further temperature compensation adjustments will not occur.
TC Max Temperature Adjust	°C or °F	-40 to 70°C or -40 to 158°F	Above this temperature, further temperature compensation adjustments will not occur.
TC mV Per Degree Per Cell	mV/cell/(°C or °F)	0-10 for °C 0-5.6 for °F	The temperature compensation adjustment to the "Float Voltage Per Cell" setting or "VOLTS PER CELL" rotary switches setting on the UIM.  As the temperature of the battery pack decreases below 25°C (77°F), the float voltage per cell is increased by this value. As the temperature of the battery pack increases above 25°C (77°F), the float voltage per cell is decreased by this value.
Automatic Continuity Test	None	Disabled or Enabled	When "Enabled" is selected, the automatic continuity test occurs using the settings below.
Continuity Test Interval	Days	1-255	The interval in days for the automatic continuity test to occur. For example, entering a value of "1" would trigger an automatic continuity test cycle every day.

Continuity/Battery Load Test Voltage per Cell	V	1.00-3.00	<p>The float voltage is lowered to this value to check for battery continuity and to do battery load test. 1.75V = default for flooded lead-acid</p> <p>This setting is also used when either the "Start Manual Continuity Test" or "Start Manual Battery Load Test" button is pressed on the webserver "Dashboard" page in the "Manual Control" section.</p>
---	---	-----------	---

### **Local Profile**

The "Local Profile" section displays the "VOLTS PER CELL" and "NUMBER OF CELLS" settings from the rotary switches on the UIM. See the "Float Voltage Per Cell" and "Number of Cells" rows in the Charge Profile table above for value ranges for the rotary switches.

## **11.4. Configuration >> Alarm Settings**

Each system alarm is individually configurable as is shown in Figure 11.4-1. The table below outlines the alarms available on the "Configuration >> Alarm Settings" page, as well as the trigger level units and trigger level values for each alarm. Furthermore, each alarm can be individually configured as follows:

- Each alarm can be enabled or disabled separately as required for the application. The Continuity Fault/Battery Load alarm cannot be permanently disabled but will switch from disabled to enabled when either of these tests begin and when completed will change back to disabled.
- A delay can be set between 0-1440 minutes. If the alarm condition clears itself within the delay time, the alarm is not generated. The delay time for Continuity Fault/Battery Load alarm is not settable.
- A priority of "Major", "Minor", and "Warning" can be selected. "Major" alarms are displayed as Red on the "Dashboard" page. "Minor" alarms are displayed as Yellow on the "Dashboard" page. "Warnings" are displayed as Green on the "Dashboard" page. See Section 11.1 for examples. Warning alarms do not trigger the RED UIM alarm LED to be ON.
- Manual clearing can be enabled or disabled. If enabled, the alarm will not automatically clear itself if the alarm condition no longer persists and manual clearing is required. **THIS FEATURE IS CURRENTLY NOT ACTIVE and disabled is the default setting.**
- Activation of the "ALARM RELAY" terminal contacts on the UIM can be enabled by selecting the "K1" in the RELAY column of the alarm settings for each alarm type.
- Deactivation of the "ALARM RELAY" terminal contacts on the UIM can be enabled by selecting the "-" in the RELAY column of the alarm settings for each alarm type. With this selected only alarms with "K1" selected will trigger the contact to change states.

High DC Voltage Shutdown is a factory set offset of 0.08 V/C above the Battery Voltage High Alarm set point. If the battery voltage is above this value, after one (1) minute the charger will shutdown and not restart to protect the batteries. After the high voltage issue has been resolved, the charger can be restarted by switching off all AC and DC breakers on the unit and then switching them back on.

<b>Name</b>	<b>Trigger Level Units</b>	<b>Trigger Level Values</b>
AC Input Power Lost	None	N/A
AC Input Voltage High	V	90-300
Battery Voltage Low	V/cell	0.80-4.00
Battery Voltage High	V/cell	0.80-4.00
Battery Temperature Low	°C or °F	-40 to 70°C or -40 to 158°F
Battery Temperature High	°C or °F	-40 to 70°C or -40 to 158°F



Min DC Output Current  Maximum settable value changes with number of valid iPMs per chassis (with no iPMs inserted, range defaults to maximum iPMs per chassis)  Min DC output current has 0.1A hysteresis and the lowest setting allowed is 0.2A.	A	<u>24V &amp; 48V</u> Up to 10.0 per iPM  <u>130V</u> Up to 4.0 per iPM
iPM Fault	None	N/A
iPM Communication Lost	None	N/A
iPM Incorrect DC Voltage	None	N/A
UIM Fault	None	N/A
Battery Temp Sensor Fault	None	N/A
Remote DC Voltage Sensing Fault	None	N/A
Ground Fault Detection	mA	1.50-4.00
Continuity Fault/Battery Load	V/cell	0.80-4.00

Name	Alarm	Trigger Level	Delay[m]	Priority	Manual Clearing	Relay	Action
AC Input Power Lost	Enabled	---	0	Major	Disabled	K1	
AC Input Voltage High	Enabled	265 V	0	Major	Disabled	K1	
Battery Voltage Low	Enabled	2.00 V/cell	0	Major	Disabled	K1	
Battery Voltage High	Enabled	2.42 V/cell	0	Major	Disabled	K1	
Battery Temperature Low	Enabled	30 °F	0	Major	Disabled	K1	
Battery Temperature High	Enabled	130 °F	0	Major	Disabled	K1	
Min DC Output Current	Enabled	0.40 A	1	Major	Disabled	K1	
iPM Fault	Enabled	---	0	Major	Disabled	K1	
iPM Communication Lost	Enabled	---	0	Major	Disabled	K1	
iPM Incorrect DC Voltage	Enabled	---	0	Major	Disabled	K1	
UIM Fault	Enabled	---	0	Major	Disabled	K1	
Battery Temp Sensor Fault	Enabled	---	0	Major	Disabled	K1	
Remote DC Voltage Sensing Fault	Enabled	---	0	Major	Disabled	K1	
Ground Fault Detection	Enabled	4.00 mA	0	Major	Disabled	K1	
Continuity Fault/Battery Load	Enabled	1.75 V/cell	0	Major	Disabled	K1	

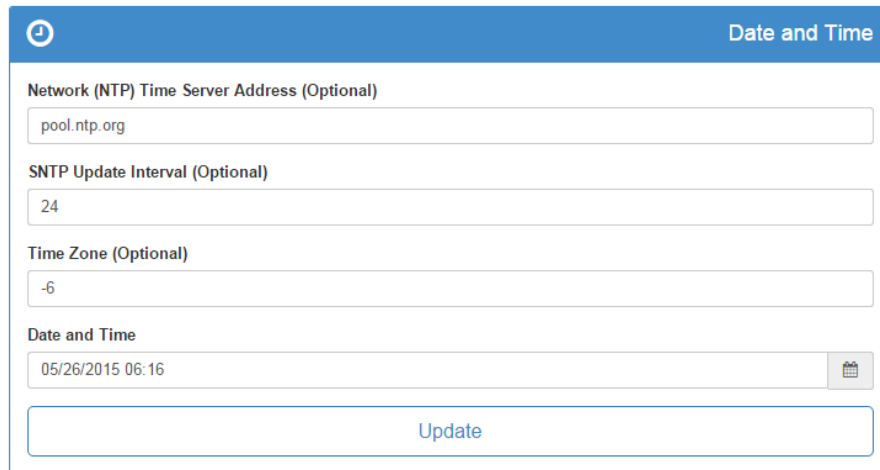
**Figure 11.4-1: Configuration >> Alarm Settings Page**

---

## 11.5. Configuration >> Date and Time Settings

The “Configuration >> Date and Time Settings” page is shown in Figure 11.5-1. The system date and time is displayed in the “Date and Time” control. This control can be used to manually change the system date and time.

Optionally, the system date and time can be synchronized with a network (NTP) time server by setting the “Network (NTP) Time Server Address”, “SNTP Update Interval”, and “Time Zone” controls.



The screenshot shows a web interface for configuring the system's date and time. The page title is "Date and Time". It contains the following fields and controls:


- Network (NTP) Time Server Address (Optional):** A text input field containing "pool.ntp.org".
- SNTP Update Interval (Optional):** A text input field containing "24".
- Time Zone (Optional):** A text input field containing "-6".
- Date and Time:** A text input field containing "05/26/2015 06:16" and a calendar icon to the right.
- Update:** A large blue button at the bottom of the form.

*Figure 11.5-1: Configuration >> Date and Time Settings Page*

## 11.6. Configuration >> Ethernet Settings >> Ethernet Port

The “Ethernet Port” section on the “Configuration >> Ethernet Settings” page is shown in Figure 11.6-1. See Section 10 for details.

---

 Ethernet Port

Physical Address  
68-27-19-2B-97-84

Address Mode  
Manual (Static) ▼

UIM Network Name  
UIM

IP Address  
10.10.10.210

Subnet Mask  
255.255.255.0

Gateway Address  
0.0.0.0

Primary DNS Address  
0.0.0.0

Secondary DNS Address  
0.0.0.0

Web Page Refresh Rate  
500 ms ▼

CLP Button Refresh Rate  
500 ms ▼

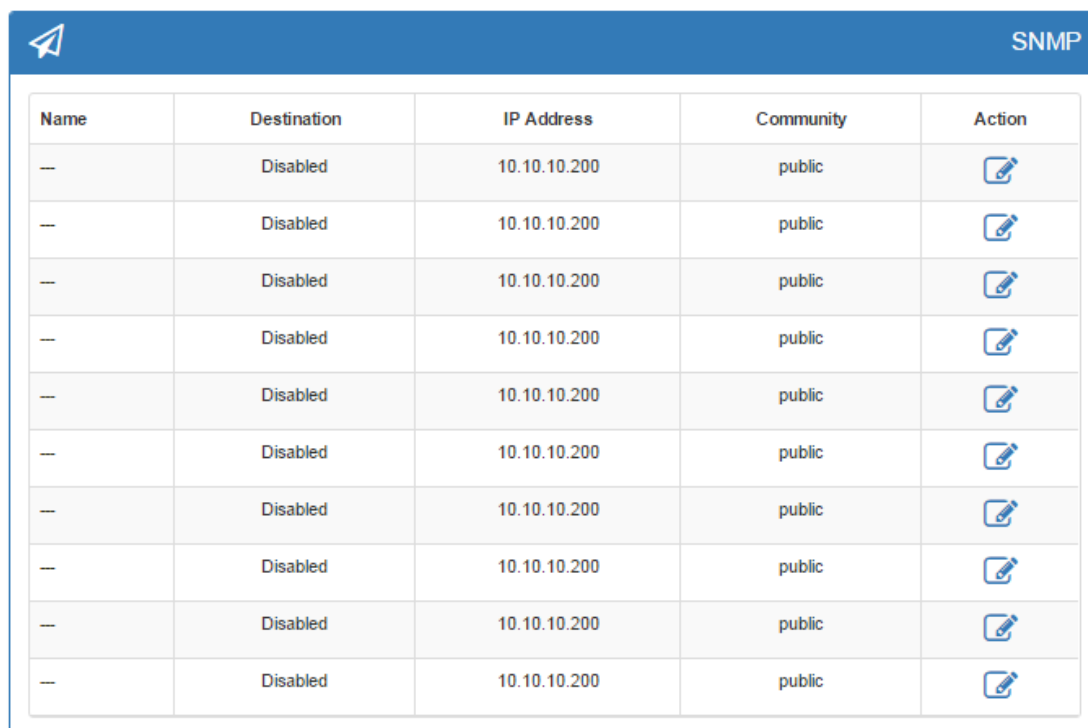
SNMP Heartbeat Refresh Rate (hours)  
0

Update

**Figure 11.6-1: Ethernet Port Section of the Configuration >> Ethernet Settings Page**

## 11.7. Configuration >> Ethernet Settings >> SNMP

Simple Network Management Protocol (SNMP) is a standard protocol for automatically sending alarms over Ethernet. The “SNMP” section on the “Configuration >> Ethernet Settings” page is shown in Figure 11.7-1. Up to 10 destinations can be enabled, named, and assigned IP addresses. When an enabled alarm is triggered or cleared (see Section 11.4), an SNMP trap will be sent over Ethernet to all enabled SNMP destinations. The enabled SNMP destinations will also receive the SNMP Heartbeat data depending on the SNMP Heartbeat Refresh Rate setup, see section 10.4.



Name	Destination	IP Address	Community	Action
--	Disabled	10.10.10.200	public	
--	Disabled	10.10.10.200	public	
--	Disabled	10.10.10.200	public	
--	Disabled	10.10.10.200	public	
--	Disabled	10.10.10.200	public	
--	Disabled	10.10.10.200	public	
--	Disabled	10.10.10.200	public	
--	Disabled	10.10.10.200	public	
--	Disabled	10.10.10.200	public	
--	Disabled	10.10.10.200	public	

Figure 11.7-1: SNMP Section of the Configuration >> Ethernet Settings Page











## 11.8. Configuration >> User Accounts

The “Configuration >> User Accounts” page can only be accessed by users with “User Roles” of “Administrator”. The access provided to each of the four (4) different “User Roles” is outlined in the table below.


	Dash-board	Configuration							History
		System Settings	Charge Settings	Alarm Settings	Date and Time Settings	Ethernet Settings	User Accounts	Upgrades	
Administrator	R/W	R/W	R/W	R/W	R/W	R/W	R/W	R/W	R/W
Power User	R/W	R/W	R/W	R/W	R/W	R/W	-	R/W	R/W
User	R/W	R/W	R	R	R/W	R	-	R	R/W
Guest	R	R	R	R	R	R	-	R	R/W

**R: Read (Does NOT Include Pressing Buttons)**

**W: Write (Includes Pressing Buttons, Does NOT Include Deleting)**

Users			
Name	User	User Role	Action
admin	Enabled	Administrator	
Tech	Enabled	Power User	
guest2	Enabled	Guest	
guest3	Enabled	Guest	
guest4	Enabled	Guest	
guest5	Enabled	Guest	
guest6	Enabled	Guest	
guest7	Enabled	Guest	
guest8	Enabled	Guest	
guest9	Enabled	Guest	

**Figure 11.8-1: Configuration >> User Accounts Page**

 admin

**User**

**Name**  
  
 Max = (20 characters)

**User Role**

Change Password

**Password**  
  
 Max = (20 characters)

**Re-enter Password**  
  
 Max = (20 characters)

**Figure 11.8-2: Options Available When Editing a User Account**

## 11.9. Configuration >> Upgrades

The “Configuration >> Upgrades” page displays the current versions of the iPM Firmware (see Figure 11.9-1), UIM Firmware (see Figure 11.9-2), and Webserver Firmware (see Figure 11.9-3).

The iPM Firmware and UIM Firmware each have two (2) “banks” for holding up to two (2) versions of firmware. The currently loaded iPM firmware version is found in the Slot ID rows under firmware. When a new firmware version is uploaded to the UIM to be sent to the iPM's, that version will be displayed in the Bank 1 or Bank 2 rows under firmware.

The iPM Firmware can be upgraded by (1) selecting a firmware file and uploading it into a bank using the appropriate “Upload Into Bank” button, (2) selecting the “Bank #” with the desired “Firmware”, (3) selecting the “Slot ID” numbers for the iPMs that you would like upgrade, and (4) pressing the “Upgrade” button.

**Step 1: Select the Bank # with the desired firmware**

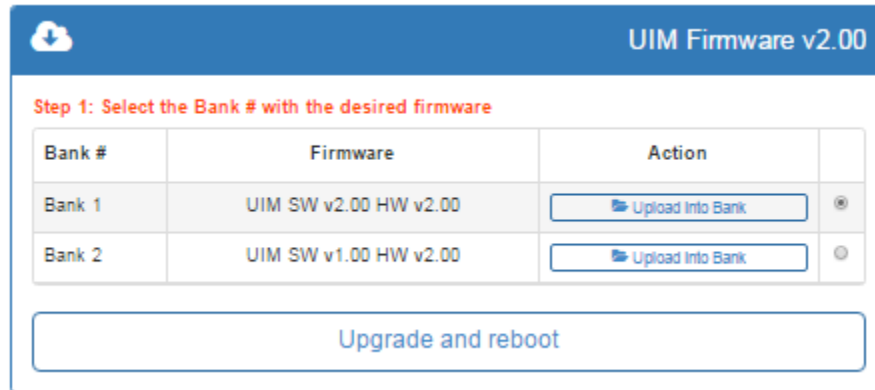
Bank #	Firmware	Action
Bank 1	iPM-SMBC-130V480W SW v9.07 HW v1.00	<input type="button" value="Upload Into Bank"/>
Bank 2	iPM-SMBC-130V480W SW v9.06 HW v1.00	<input type="button" value="Upload Into Bank"/>

**Step 2: Select the Slot IDs to be upgraded**

Slot ID	Model	Hardware	Firmware	<input type="checkbox"/>
1	iPM-SMBC-130V480W	HW v1.00	SW v9.07	<input type="checkbox"/>
2	iPM-SMBC-130V480W	HW v1.00	SW v9.07	<input type="checkbox"/>
3	iPM-SMBC-130V480W	HW v1.00	SW v9.07	<input type="checkbox"/>
4	iPM-SMBC-130V480W	HW v1.00	SW v9.07	<input type="checkbox"/>
5	iPM-SMBC-130V480W	HW v1.00	SW v9.07	<input type="checkbox"/>
6	iPM-SMBC-130V480W	HW v1.00	SW v9.07	<input type="checkbox"/>
7	iPM-SMBC-130V480W	HW v1.00	SW v9.07	<input type="checkbox"/>
8	iPM-SMBC-130V480W	HW v1.00	SW v9.07	<input type="checkbox"/>

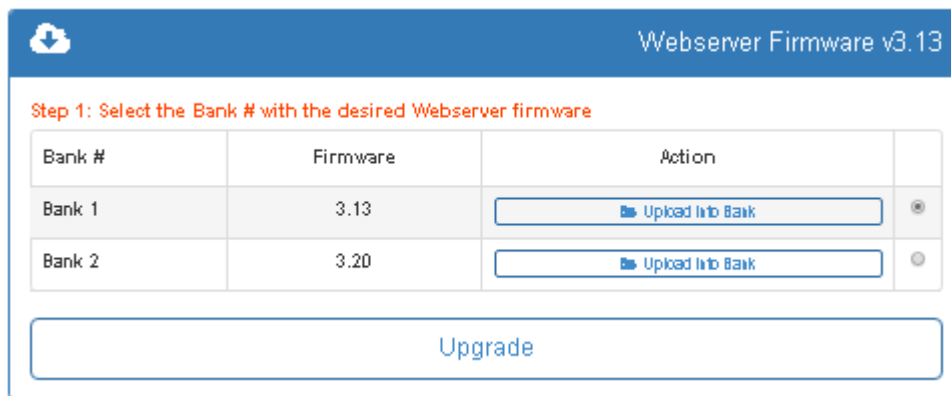
**Figure 11.9-1: iPM Firmware Section of the Configuration >> Upgrades Page**

The UIM controllers current version of firmware is displayed in the blue box labeled UIM firmware vX.XX. The UIM code version that has been uploaded into the bank or banks will be displayed in the Bank 1 or Bank 2 rows under the Firmware column. The UIM Firmware can be upgraded by (1) selecting a firmware file and uploading it into a bank using the appropriate “Upload Into Bank” button, (2) selecting the “Bank #” with the desired “Firmware”, and (3) pressing the “Upgrade and reboot” button.



**Figure 11.9-2: UIM Firmware Section of the Configuration >> Upgrades Page**

The UIM webserver firmware current version is displayed in the blue box labeled Webserver Firmware vX.XX. When a new version of code has been uploaded into the bank or banks, it will be displayed in the Bank 1 or Bank 2 rows under the Firmware column. The UIM Firmware can be upgraded by (1) selecting a firmware file and uploading it into a bank using the appropriate “Upload Into Bank” button, (2) selecting the “Bank #” with the desired “Firmware”, and (3) pressing the “Upgrade” button.



**Figure 11.9-3: Webserver Firmware Section of the Configuration >> Upgrades Page**

## 11.10. History

On the “History” page, you will currently find the “Event Records” section, which is shown in Figure 11.10-1. All logon, logoff, manual output off, manual or automatic output on, equalize performed, continuity test values and fault, battery load test time events and the alarms that are enabled on the “Configuration >> Alarm Settings” page (see Section 11.4) will be logged. Separate records are logged when an alarm becomes Active (triggered) and when an alarm is Cleared.


The “Event Records” section includes two (2) sub-sections. The “Most Recent Event Records” sub-section includes a table with the 50 most recent event records. These records can be sorted by clicking on the table headers, searched using the “Search” box, or downloaded as a comma-separated values (CSV) file to be opened and analyzed in a spreadsheet program/app, such as Microsoft Excel (see Figure 11.10-2 for an example CSV file).

The “Download All Event Records” sub-section allows you to download all available events records as a CSV file. When a download is selected, a status bar will indicate the download progress and when the download is complete the status bar will disappear. The total number of available records is listed in this sub-section. The charger can store over 10,000 records. When the record storage is full, the oldest 300 records (approximately) will be permanently deleted to make room for new records.

Download in progress...


53%

Historical Event Records

Most Recent Event Records Search 

ID	Time	Source	Name	Value
84	2024-03-15 13:58:37	UIM	Logon	0
83	2024-03-15 13:54:29	UIM	Logoff	0
82	2024-03-15 13:24:49	UIM	Battery Voltage High	Cleared
81	2024-03-15 13:24:34	UIM	Battery Voltage High	151.22 V
80	2024-03-15 13:24:28	UIM	Logon	0
79	2024-03-15 13:23:18	UIM	Min DC Output Current	0.00 A
78	2024-03-15 13:22:14	UIM	Remote DC Voltage Sensing Fault	Active
77	2024-03-15 13:22:13	UIM	Battery Voltage High	Cleared
76	2024-03-15 13:22:13	UIM	Battery Voltage Low	69.89 V

Showing 1 to 50 of 50 rows 50 ▲ rows per page


**Download All Event Records**  \*.csv


New to the History web server page Event Records is the Clear Alarm Events button that allows an Administrator or Power User the ability to clear the event records if necessary. It is recommended to always download all event records before clearing them to prevent loss of this information.



Alarm records include the following fields.


Field	Description
ID	Sequential record ID. The ID resets back to "1" for new records when the record storage is full and the oldest records have been deleted in order to make room for new records.
Time	The date and time when the event occurred.
Source	The source of the event ("UIM" for the User Interface Module or iPM and slot number for the intelligent Power Modules.).
Name	The name of the event (for example, "AC Input Power Lost").
Type	<ul style="list-style-type: none"> <li>• "0" for records where an alarm was cleared.</li> <li>• "1" for records where an alarm became active (triggered).</li> </ul> This field is not on the web page, but is included with the downloaded CSV file.
Value	<ul style="list-style-type: none"> <li>• "Cleared" for records where an alarm was cleared.</li> <li>• "Active" for records where an alarm became active (triggered) for alarms that do not have a "Trigger Level" associated with them (for example, "AC Input Power Lost").</li> <li>• For alarms that do have a "Trigger Level" associated with them (for example, "Min DC Output Current"), the actual value at the time that the alarm was triggered is included in the "Value" field.</li> <li>• UIM fault codes are described by their name field and are referenced in Figure 11.10-4.</li> <li>• iPM fault codes in the value column will have "Active - Code: #" where the # will be replaced with a number based off the iPM fault code list. Reference the iPM Fault Code chart in Figure 11.10-3.</li> <li>• User name for logon or logoff.</li> <li>• Performed for any Equalize charge done (if manually stopped record will still be added).</li> <li>• Minutes of the Battery Load Test.</li> <li>• Voltage value for Continuity Test and Continuity Fault.</li> </ul>

 Event Records

**Most Recent Event Records**  


ID	Time	Source	Name	Value
73	2024-03-15 13:09:01	UIM	Battery Load Test	1 mins
72	2024-03-15 13:08:14	UIM	Continuity Fault	Cleared
71	2024-03-15 13:08:14	UIM	Continuity Test	146.63 V
70	2024-03-15 13:07:44	UIM	Continuity Test	115.51 V
69	2024-03-15 13:07:39	UIM	Continuity Fault	115.47 V
68	2024-03-15 13:04:28	UIM	Equalize	Performed
67	2024-03-15 13:04:14	UIM	Battery Voltage Low	Cleared
66	2024-03-15 13:04:13	UIM	Remote DC Voltage Sensing Fault	Cleared
65	2024-03-15 13:04:11	UIM	Manual ON	Code: 1


Showing 1 to 50 of 50 rows  rows per page

[Download All Event Records](#)  \*.csv

Total Number of Records: 73


 Clear Alarm Events

 Event Records


**Most Recent Event Records**  

ID	Time	Source	Name	Value
67	2024-03-15 13:04:14	UIM	Battery Voltage Low	Cleared
66	2024-03-15 13:04:13	UIM	Remote DC Voltage Sensing Fault	Cleared
65	2024-03-15 13:04:11	UIM	Manual ON	Code: 1
64	2024-03-15 13:04:07	UIM	Remote DC Voltage Sensing Fault	Active
63	2024-03-15 13:04:06	UIM	Battery Voltage Low	69.47 V
62	2024-03-15 13:04:05	UIM	Manual OFF	Code: 0
61	2024-03-15 13:03:52	UIM	Logon	admin
60	2024-03-15 13:03:47	UIM	Logoff	admin

Showing 1 to 50 of 50 rows  rows per page

[Download All Event Records](#)  \*.csv

Total Number of Records: 73

 Clear Alarm Events

**Figure 11.10-1: Event Records Section of the History Page**

	A	B	C	D	E	F
1	ID	Time	Source	Name	Type	Value
2	1	2/7/2018 16:07	UIM	Battery Voltage Low	1	10.49 V
3	2	2/7/2018 16:08	UIM	Battery Voltage Low	0	Cleared
4	3	2/7/2018 16:08	UIM	Battery Temp Sensor Fault	1	Active
5	4	2/7/2018 16:08	UIM	Battery Temp Sensor Fault	0	Cleared
6	5	2/7/2018 16:09	UIM	Battery Voltage Low	1	6.18 V
7	6	2/7/2018 16:09	iPM: #2	iPM Fault	1	Active-Code: 2
8	7	2/7/2018 16:09	UIM	Battery Voltage Low	0	Cleared
9	8	2/7/2018 16:09	UIM	Battery Voltage Low	1	7.43 V
10	9	2/7/2018 16:09	UIM	Remote DC Voltage Sensing Fault	1	Active
11	10	2/7/2018 16:10	UIM	Remote DC Voltage Sensing Fault	0	Cleared
12	11	2/7/2018 16:10	iPM: #2	iPM Fault	0	Cleared
13	12	2/7/2018 16:10	UIM	Battery Voltage Low	0	Cleared

**Figure 11.10-2: Example CSV File Downloaded from the Event Records Section of the History Page**

iPM Fault	iPM Error Codes Reported in Event Records History ***	iPM LED Status	iPM DC Output Status	Description / Recommended Action
AC Voltage Surge	1	Fast Blink Red	OFF	An AC voltage surge event > 330Vac occurred. Fault should clear when AC is within limits, if not replace iPM module or modules.
AC Voltage Low	2	Fast Blink Red	OFF	The AC voltage dropped below 80 volts. The iPM will recover when AC voltage goes back above 90 volts.
Over Temperature Shutdown	32	Fast Blink Red	OFF	This fault triggers when the heatsink temperature $\geq 115^{\circ}\text{C}$ ( $239^{\circ}\text{F}$ ). The iPM will shut down for protection and turns back on at $100^{\circ}\text{C}$ ( $212^{\circ}\text{F}$ ).
Heat Sink Temperature High	256	Normal Green Mode	ON	This fault triggers when the heatsink temperature goes above $100^{\circ}\text{C}$ ( $212^{\circ}\text{F}$ ). The fault will clear below $100^{\circ}\text{C}$ ( $212^{\circ}\text{F}$ ).
Heat Sink Temperature Failure	512	Normal Green Mode	ON	The heatsink temperature sensor has failed. The iPM will continue to function but should be replaced so as to protect against additional damage.
DC Fuse Open	2048	Solid Red	OFF	The DC output fuse has opened. Replace the iPM.
Power Stage Failure	4096	Solid Red	OFF	The iPM had or has a power stage problem. If fault code does not clear replace the iPM.
Over Voltage Shutdown	8192	Fast Blink Red	OFF	The iPM output voltage is either too high or is connected to a DC supply that is too high. Verify battery voltage and if fault does not clear replace iPM.
iPM Plug-in Failure	16384	Solid Red	OFF	The fault code happens when the short pin on the iPM edge connector is not making proper contact with the backplane shelf unit connector. Verify proper iPM engagement with the shelf connector.
*** If a value other than the number listed above is recorded in the event records then that means that more than one iPM fault code was active at that time. The values will be added together. (Example: Heat sink Temperature High and Over Temperature Shutdown will give you a $256+32=288$ )				

**Figure 11.10-3 iPM Fault Codes**

UIM Fault	Description / Recommended Action
AC Input Power Lost	The UIM doesn't detect a high enough AC input voltage. Verify AC input voltage at the charger is $\geq 100$ Vac and the circuit breaker is not open. See troubleshooting section if AC input measures above 100 Vac and AC Input Lost alarm is still active. The alarm trip level is lower than the alarm reset level, so if input voltage was low, it must go back above the reset level to clear the alarm automatically.
AC Input Voltage High	The UIM AC input voltage reading is or was above the value specified for the AC Input Voltage High alarm trigger level. Verify AC input voltage applied to the charger is below the AC Input Voltage High trigger level by at least five (5) volts to clear the alarm.
Battery Voltage Low	The battery voltage sensed by the UIM is or was below the Battery Voltage Low alarm trigger level. The trigger level is the alarm volts per cell (V/C) value times the number of cells setting (example: 2.00 V/C and 12 cells equals 24.0 volts alarm value). The voltage sensed by the UIM must go above this trigger level by 0.125 V/C to clear the alarm (example: 2.125 V/C and 12 cells equals 25.50 volts). Verify charger float voltage settings including temperature compensation (if enabled) and alarm settings. Verify the charger is outputting the necessary voltage and current to maintain the battery float voltage under system load.
Battery Voltage High	The battery voltage sensed by the UIM is or was above the Battery Voltage High alarm trigger level. The trigger level voltage is the alarm V/C value times the valid number of cells setting (example: 2.42 V/cell and 12 cells equals 29.04 V alarm value). The voltage sensed by the UIM must go below this trigger level by 0.125 V/C to clear the alarm (example: 2.295 V/C and 12 cells equals 27.54 volts). Verify charger float voltage settings including temperature compensation (if enabled) and alarm settings. Verify the charger is outputting the necessary voltage and current to maintain the battery float voltage under system load.
Battery Temperature Low	The battery temperature sensed by the UIM is or was below the Battery Temperature Low alarm trigger level. The battery temperature sensed by the UIM must go above this trigger value by 1°C or 2°F to clear the alarm. If the battery temperature reading appears to be wrong (based on an alternate temperature reading), then disconnect the remote battery temperature sensor from the charger until it can be verified or replace the sensor. With the sensor not connected, the charger float voltage will go to the non-temperature compensated value.
Battery Temperature High	The battery temperature sensed by the UIM is or was above the Battery Temperature High alarm trigger level. The battery temperature sensed by the UIM must go below this trigger value by 1°C or 2°F to clear the alarm. Verify the charger voltage is proper to make sure it is not overcharging the battery causing the elevated temperature. If the battery temperature reading appears to be wrong (based on an alternate temperature reading), then disconnect the remote battery temperature sensor from the charger until it can be verified or replace the sensor. With the sensor not connected, the charger float voltage will go to the non-temperature compensated value.
Min DC Output Current	The DC output current sensed by the UIM is or was below the Min DC Output Current alarm trigger level. Verify the charger output is at the proper voltage level for the charger settings and the charger load is maintained at a current level higher than this alarm setting.
iPM Fault	The UM received communication from an iPM of a fault condition. See iPM fault codes in Figure 11.10-3 for information about recommended action.

iPM Communication Lost	The UIM is unable to receive communication signals from one or more iPMs. The number of iPMs is setup in system settings, so if the UIM is receiving communications from fewer than that number of iPMs setup, then this alarm will be triggered. Verify system settings match with the number of working iPMs in the system. Observe the webpage iPM dashboard section to determine if iPMs are communicating with the UIM. iPMs must have AC voltage to communicate with the UIM. Also, a slow blinking RED LED on an iPM indicates loss of communication with the UIM. If this happens with just one iPM, then check for a possible bad connection with the backplane connector or the iPM maybe working improperly. If this is happening with multiple iPMs, check the cable connections between the backplanes and the UIM. A malfunctioning iPM can cause problems with the communication bus, so remove iPMs one at a time to determine which one is causing the problem. If the UIM is unable to see any iPMs and cable connections are good, then replace the UIM.
iPM Incorrect DC Voltage	iPM Incorrect DC Voltage alarm is an indication that the UIM system settings and the iPM voltage type are not the same. The charger chassis is keyed to prevent the wrong iPM voltage type from being plugged into the chassis. If this is a replacement UIM, then the system settings for the UIM must be setup for the charger iPM voltage type. See UIM replacement information in section 13.2 or contact your service agent.
UIM Fault	If the UIM fault code happens, then completely power the system down and back up once. If fault code does not clear, then replace the UIM.
Battery Temp Sensor Fault	The Battery Temp Sensor Fault is triggered when Remote Battery Temperature is enabled in system settings and either a functioning battery temperature sensor cable is not connected, or the temperature sensor cable connected to the UIM is malfunctioning. If for some reason a verified good cable is connected and the fault does not clear, then replace the UIM.
Remote DC Voltage Sensing Fault	The Remote DC Voltage Sensing Fault is triggered when Remote Battery Voltage is enabled in system settings and either a functioning battery sense cable is not connected to the UIM or the battery or the cable wiring is open. If for some reason a verified good cable is connected and the fault does not clear, then replace the UIM.
Ground Fault Detection	The GFD module monitors the current levels between both [1] DC positive (+) and ground and [2] DC negative (-) and ground. If the "Ground Fault Detection" alarm is enabled in the alarm settings, then it generates an alarm if either current level is above the trigger level. Determine what is causing the current path and remove this path to clear the alarm. It may be necessary to isolate the charger from the battery bus to determine where the issue is. The GFD alarm current has to be 0.5mA below the alarm trigger level to clear the alarm. The alarm can also be disabled by removing the jumpers on the GFD circuit board inside the charger. If the GFD alarm board is not functioning properly the UIM assembly will need replaced.
High Voltage Shutdown or Unknown	This alarm name will depend on the firmware version in your unit. It indicates the battery voltage sensed by the UIM is or was above the alarm trigger level for one (1) minute for this fault code to appear and will shut down the charger output. This trigger level voltage is the Battery Voltage High alarm trigger value plus 0.08 V/C (example: 2.42 V/C + 0.08 V/C = 2.50 V/C x 12 cells = 30 volts for the alarm value). The charger output will be latched off when this fault happens to protect the batteries. Also, the webpage dashboard Manual Control section will show Output Off. To clear the fault, switch off both the AC input and DC output circuit breakers to reset the UIM. After the UIM LEDs go off, switch the breakers back on and the charger output should come back on. If the fault happens again, then verify charger float voltage settings (including temperature compensation if enabled) and alarm settings. Verify the charger output voltage and current levels maintain the battery float voltage under system load.

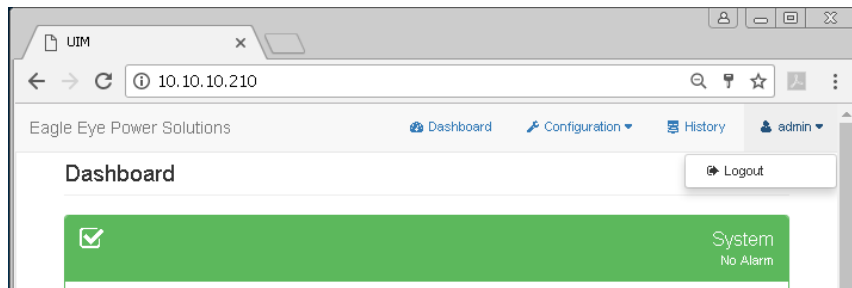
Continuity Fault	The Continuity Fault event indicates that a continuity test was performed via the manual control on dashboard or the automatic test interval settings and the Continuity Fault/Battery Load alarm setting value was met triggering this fault record. Check the charger and battery cables and connections and the battery condition then retest to clear the fault or select the Update button on the Alarm configuration page for this fault.
------------------	---

**Figure 11.10-4 UIM Fault Codes**

## 11.11. Logout

The logout tab can be found under the current user name of who is logged into the webserver at the far right top of the page. This allows logout for security before the 10 minutes of web page activity has expired. This 10 minutes is how long you can access a web page without changing to another web page on the server. A 30-minute total time is allowed before the user will be logged out automatically and required to log back in.

Users should always logout when done with web server access to free up access for other users if needed. For security reasons only one user is allowed access at a time. Closing the web server does not logout the user.



**Figure 11.11-1: Logout**

## 12. MAINTENANCE

The charger requires minimal maintenance. Keep the charger clean and all field connections are to be periodically tightened. **BE SURE THE CHASSIS IS SECURELY GROUNDED.** Maintenance should be performed on the battery/charging system as often as necessary, depending on conditions, or at least every 6 months. If any problem cannot be resolved, contact an Eagle Eye Power Solutions service agent at 1-877-805-3377.

**⚠ WARNING: DISCONNECT AND LOCK OUT BOTH AC AND DC POWER FROM THE CHARGER BEFORE ENTERING THE ENCLOSURE. CONTACT WITH LIVE COMPONENTS WITHIN THE CHARGER COULD CAUSE ELECTRICAL SHOCK, SERIOUS INJURY, OR DEATH.**

### 12.1. Check the Area Around the Charger

The area around the charger must remain clean, dry, cool, and well ventilated. Check for obstructions to airflow, clearances, or other violations of the requirements in Section 3.

**⚠ CAUTION: KEEP THE CHARGER CLEAN AND DRY, INSIDE AND OUT. FAILURE TO DO SO MAY CAUSE DAMAGE OR FAILURE OF CHARGER.**

### 12.2 Physical Cleaning

The charger itself requires little maintenance. However, elements such as dust, debris, and moisture, can adversely affect the charger and should be kept away from the charger. If they do contact the charger, they

---

must be removed. Dust, debris, or moisture will shorten the working life of the charger, if they are allowed to build up.

The ventilation slots in the enclosure should be kept clean and free of obstructions of airflow. All the components within the charger should be kept clean and free of contamination build up.

The charger is cooled by natural convection. If dust and debris are allowed to build up, they will restrict airflow and may cause components to overheat.

Moisture may cause electrical shorting or corrosion and may combine with dust and debris making them more difficult to remove. Do not use liquids to clean the charger, as they may cause damage.

Compressed air should be used to clean dust and debris from the charger and its components. It may be necessary to remove the top panel and/or iPMs from the charger enclosure to allow access to the internal parts for cleaning.


Always be careful not to bump the wiring or components. This could cause loose connections or failures.

### 12.3 Visual Inspection

Check the charger for any physical failures, such as loose connections or hardware, excessive wear, or damage. Darkened or hot terminals should be tightened or replaced.

1. Check the tightness of all field connections at the charger and battery, referencing the applicable sections of this manual and the battery manufacturer's documentation for required torque values.
2. Inspect the Alarm Relay connections ensuring the wiring is secure.
3. Verify the chassis or rack mounting hardware and torque as defined in Section 3.

## 13. TROUBLESHOOTING AND SERVICING

 **CAUTION: DO NOT OPERATE THE CHARGER IF IT IS DAMAGED OR APPEARS TO BE MALFUNCTIONING. PERSONAL INJURY OR DAMAGE TO THE CHARGER OR BATTERIES MAY RESULT. INCORRECT REASSEMBLY AFTER SERVICING THE CHARGER MAY RESULT IN RISK OF ELECTRIC SHOCK OR FIRE.**

The charger was fully tested and calibrated before leaving the factory. It was delivered ready to charge. If properly installed, the charger should require very little attention. If improper charger operation occurs, follow the step below.

- Ensure that the “AC PRESENT” LED on the UIM is illuminated; indicating that AC input power is present.
- Check the “ALARM” LED on the UIM. If this LED is illuminated, refer to Section 11.1 to determine which alarm(s) is active.
- Check the “NUMBER OF CELLS” and “VOLTS PER CELL” rotary switches on the UIM to verify their settings against the specifications of the batteries. If the “NUMBER OF CELLS” rotary switches are set to “00”, which enables software control of the float voltage value, refer to Section 11.3 to verify the “Number of Cells” and “Float Voltage Per Cell” setting values via the charger web server.
- Check the AC input and DC circuit breakers to make sure they have not tripped.
- Open the access panel on the front of the charger and make sure all the terminal block connections are tight.
- Check the polarity between the DC output terminals and the battery pack and make sure all connections are tight.
- Refer to Section 11 to verify all other charger web server settings.
- If the steps above do not solve the issue and you are qualified to do additional investigating of the issue, then see the section of BC-2500 Charger Troubleshooting chart (see section 13.1) to assist with the

troubleshooting. The charger wiring diagram (see section 14) can also be used to help in determining the cause of the issues.

- If the steps above do not solve the issue, contact your nearest Eagle Eye service agent at 1-877-805-3377.

### 13.1. Charger Troubleshooting Chart

The charts below and the UIM and iPM LEDs will assist with troubleshooting of charger issues. Refer to sections 9.1 and 9.2 of this manual for LED information. If available, use the web server, as the dashboard display of the battery voltage, DC output current, AC input voltage, iPM information, and manual control information can assist in troubleshooting. See the charger wire diagram in section 14 for additional assistance.

<b>BC-2500 CHARGER TROUBLESHOOTING</b>		
<b>Symptom</b>	<b>Possible Cause</b>	<b>Recommended Action</b>
UIM Green AC Present LED Off	AC Input Circuit Breaker is Tripped or Bad	<ol style="list-style-type: none"> <li>1) Are any iPM LEDs on? If iPM LEDs are on, then you have AC power to the charger chassis and the AC circuit breaker is good. See next possible cause. If no IPM LEDs are on, then check step 2.</li> <li>2) Carefully check AC input voltage at the input terminal block behind the access panel door. If the AC voltage at the terminals is good, then continue to step 3. If there is no AC voltage at terminals, then check the AC source.</li> <li>3) Check the AC input circuit breaker on front of charger to verify it is in the ON position. Be cautious of touching the DC connections if the DC battery voltage is still connected. If AC circuit breaker is tripped open in the OFF position, then switch the breaker to the ON position after doing a visual check of the charger unit.</li> </ol>
	No AC Input Power to UIM	<ol style="list-style-type: none"> <li>1) The UIM module gets its AC input from the backplane through a cable with a 2-pin connector which attaches to the small circuit board on the back of the UIM module. Continuity can be measured at this connection before replacing the UIM module.</li> <li>2) For safety, disconnect both the AC input and DC battery voltages from the chassis.</li> <li>3) Remove the chassis cover by loosening its screws and locate this connector on the back of the UIM board with white and black wires. The white wire should have continuity to one AC input terminal block post and the black wire to the other. If necessary, the AC input voltage can be measured here if very cautious.</li> <li>4) If you get no continuity, verify the connector on the backplane from this UIM cable is attached properly. If connections are good, then see next possible cause. If connections are bad, then the chassis will need replaced.</li> </ol>
	UIM Module is Bad	<ol style="list-style-type: none"> <li>1) The UIM module is powered by both AC and DC (minimum 6 Vdc for a 24V system and 24 Vdc for 48V and 130V systems). Remove both power sources by switching all AC and DC breakers off, and then reconnect either AC or DC. This will reboot the UIM. On power up, watch for the UIM reboot LED sequence. All LEDs should go on, and then off in a sequence. If not, then replace the UIM.</li> </ol>



		<p>2) Reapply AC input to the unit. If the green AC Present LED is now on, then verify normal charger function.</p> <p>3) If green AC Present LED is still off, replace the UIM module. Follow replacement part instructions to remove and replace with a new UIM module.</p>
UIM Status LED Off	UIM Module is Bad	<p>1) The UIM module is powered by both AC and DC (minimum 6 Vdc for a 24V system and 24 Vdc for 48V and 130V systems). Remove both power sources by switching all by AC and DC breakers off, and then reconnect either AC or DC. This will reboot the UIM. On power up, watch for the UIM reboot LED sequence. All LEDs should go on, and then off in a sequence. If not, then replace the UIM.</p> <p>2) After the power reboot, If UIM Status LED is still off and AC Present LED is on then replace the UIM module. Follow replacement part instructions to remove and replace with a new UIM module.</p>
UIM Alarm LED Does Not Turn On with Faults	UIM Module is Bad	<p>1) Verify Alarm settings first, as the Warning priority levels will not turn the Alarm LED on.</p> <p>2) The UIM module is powered by both AC and DC (minimum 6 Vdc for a 24V system and 24 Vdc for 48V and 130V systems). Remove both power sources by switching all the AC and DC breakers off, and then reconnect either AC or DC. This will reboot the UIM. On power up, watch for the UIM reboot LED sequence. All LEDs should go on, and then off in a sequence. If not, then replace the UIM.</p> <p>3) If UIM Alarm LED is still off when it should be on, then replace the UIM module. Follow replacement part instructions to remove and replace with a new UIM module.</p>
UIM Confirm Local Presence LED Does Not Turn On When Button is Pressed	User Must Be Logged In	<p>1) For Confirm Local Presence LED to stay on, a valid webserver user must be logged in, otherwise LED will go back off.</p>
	UIM Module is Bad	<p>2) The UIM module is powered by both AC and DC (minimum 6 Vdc for a 24V system and 24 Vdc for 48V and 130V systems). Remove both power sources by switching all AC and DC breakers off, and then reconnect either AC or DC. This will reboot the UIM. On power up, watch for the UIM reboot LED sequence. All LEDs should go on, and then off in a sequence. If not, then replace the UIM.</p> <p>3) Press the Confirm Local Presence Button again and if LED still does not come on replace the UIM module. Follow replacement part instructions to remove and replace with a new UIM module.</p>
Not Able to Communicate Via Ethernet Connector and WEB Server	UIM Module is Bad	<p>1) Verify the device trying to access the web server, the cable, and the Internet Protocol (IP) address are setup properly.</p> <p>2) The UIM module is powered by both AC and DC (minimum 6 Vdc for a 24V system and 24 Vdc for 48V and 130V systems). Remove both power sources by switching all AC and DC breakers off, and then reconnect either AC or DC. This will reboot the UIM. On power up, watch for the UIM reboot LED sequence. All LEDs should go on, and then off in a sequence. If not, then replace the UIM. After reboot, retry to access the UIM via the server.</p> <p>3) If unable to access the web server, then see section 10.6 to restore the factory default Ethernet port settings and retry to access the UIM via the server.</p>

		4) After the steps above are verified and the unit is still not functioning, then replace the UIM module. Follow replacement part instructions to remove and replace with a new UIM module.
All UIM LEDs are Off When Connected to Battery Voltage without AC Input Applied to Charger	DC Output Breaker Tripped or Bad	<ol style="list-style-type: none"> <li>1) Open the charger access panel and verify DC voltage is above the required power on voltage at the DC terminal block. The UIM module needs a minimum of 6 Vdc for a 24V system and 24 Vdc for 48V and 130V systems to power on.</li> <li>2) If voltage is above required power on voltage, verify the DC breaker is closed and not tripped open. If the breaker is still good, then see next possible cause.</li> <li>3) If DC breaker is bad, then replace it with the same type and rating after doing a visual check of charger unit.</li> </ol>
	No DC Voltage at the UIM	<ol style="list-style-type: none"> <li>1) The UIM gets DC voltage through the 5-wire cable from the back plane to a connector which attaches on the left side of the UIM board assembly.</li> <li>2) For safety, disconnect both the AC input and DC battery voltage from the chassis.</li> <li>3) Remove the screws that hold the UIM to its panel and tilt the UIM to access this connector.</li> <li>4) Continuity can be measured at this connector to the DC output terminal block. The red wire on the cable should have continuity with the DC plus at the terminal block and the black wire on the cable should have continuity with the DC minus terminal. If necessary, the DC voltage can be measured here if very cautious.</li> <li>5) If you get no continuity, verify the connector on the backplane is attached properly. If connections are good, then see next possible cause. If connections are bad, then the chassis will need replaced.</li> </ol>
	UIM Module is Bad	1) After the steps above are verified and the unit is still not functioning, then replace the UIM module. Follow replacement part instructions to remove and replace with a new UIM module.
No iPM LED's are ON in Charger Chassis Unit	No AC Input Power to iPM	<ol style="list-style-type: none"> <li>1) Is the UIM green AC present LED on? If the green LED is on, then the AC input breaker is good and you have AC Input to the charger shelf unit via the 2 wire connector to the UIM board. If UIM green AC Present LED is off, then see that symptom section.</li> <li>2) iPM modules do not require a working UIM module so if all iPM modules LEDs are off then continue to next possible cause.</li> </ol>
	Manual Control / Output Control Turned OFF	<ol style="list-style-type: none"> <li>1) Using the Web server interface, check to make sure the charger output has not been turned off by using the interface control. Check the Current State Box on the dashboard.</li> <li>2) Turn the charger output back on using the dashboard control if it was off.</li> </ol>
iPM or iPM's LED's blinks green once every 5 seconds	Manual Control / Output Control Turned OFF	1) If all system iPM's are in this mode and it is not desired, then turn the output back on from web page. This LED mode is normal for new firmware versions' indicating the iPM is still powered but the DC output current has been turned off.
	iPM in Power Saving Mode	1) If only some of the iPM's are in this mode, then the system is in power saving mode and those iPMs are not needed to maintain the

		necessary charger output current. See system settings on web page if this mode is not desired.
No iPM LED's are ON in Charger Chassis Unit Continued	iPM Module Connector or Backplane Connection Bad	<p>1) Using the Web server interface, go to the dashboard page and look at the iPM section and verify if the UIM is able to connect with them. Each iPM is connected to the UIM via the backplane and should be displayed on the dashboard.</p> <p>2) If the iPM is not displayed on the dashboard, then remove the screws holding the iPM in and pull the iPM out of the chassis. Inspect the connector on the backplane chassis and also on the iPM. If no issues are found, reinstall iPM making sure connector is fully engaged with the backplane board.</p> <p>3) On AC power up, the iPM LEDs should do a power up sequence with LED changing from red to green. If this does not happen, then see next possible cause.</p>
	iPM Module is Bad	<p>1) If it has been determined that the above possible causes and actions have not resolved the issue then, replace the iPM with the proper iPM type for the charger system.</p>

### 13.2. UIM Replacement Information

If for any reason a UIM assembly is needed to be replaced, follow the procedure below to make sure the replacement UIM is setup properly for your system and functioning properly.

1. Install the UIM assembly using the instructions provided with the service part.
2. If using the UIM rotary switches to control float voltage make sure switches are set for the desired settings. If using web page UIM control then after AC is applied check all settings for proper setup.
3. With the proper voltage iPMs in the charger chassis apply AC power to the unit. Verify setting on web page or on rotary switches.
4. The UIM assembly will connect with the iPMs and determine the proper Nominal DC Output Voltage setting for the System Setting and adjust some charger settings based off of this information.
5. If the UIM assembly was factory set for a default of 130-volt nominal and is being used in a 48-volt nominal system, the IPMs will be turned off on power up (iPM LEDs off). This will also happen if the UIM assembly was setup for as a 48-volt nominal system and is now being used in a 130-volt nominal system. The 24V UIM is a totally different board assembly and will not work in the 48V or 130V systems.
6. One of two methods will need to be used to allow the iPMs to be turned on. Either reboot the UIM assemblies by removing all UIM power sources (AC and DC) or using the web page controls on the dashboard go to Manual Control, Output Control and click on Turn Output On. Charger output should come on and iPM LEDs will come on.
7. With DC battery not connected you can check for proper float voltage at the charger terminal block.

### 13.3. Service Parts List

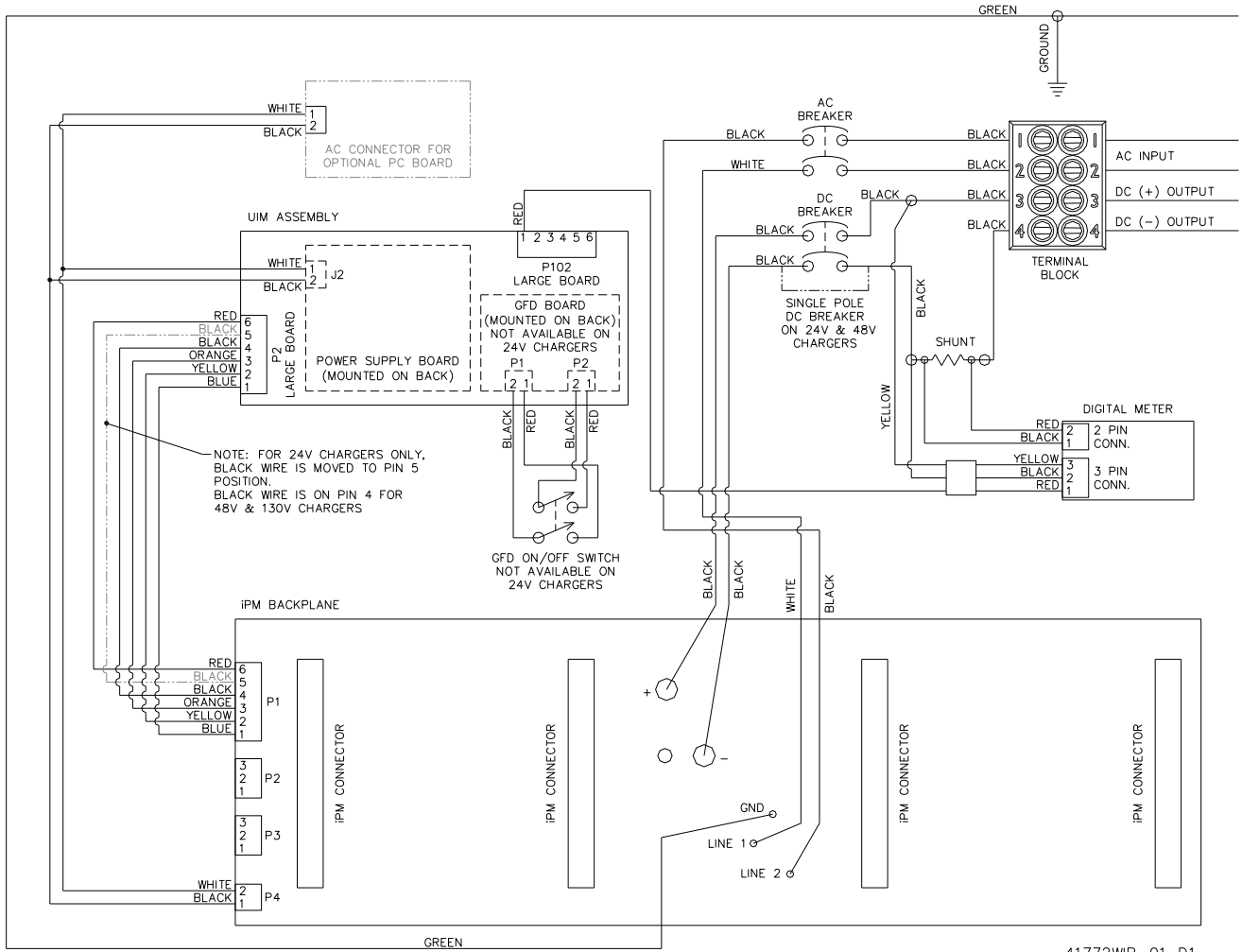
Description	24V	
	4-Slot	8-Slot
Input AC Circuit Breaker, Standard	41931S (30A)	41933S (60A)
Input AC Circuit Breaker, High Interrupt	41932S (30A)	41934S (60A)
Output DC Circuit Breaker	41963S (50A)	
Intelligent Power Module (iPM)	42508-C02S	
Alarm Box Expansion Kit	42893S	
Alarm Box + Modbus RS-323 Expansion Kit	42896S	
Alarm Box + Modbus RS-485 Expansion Kit	42989S	
Modbus RS-323 Expansion Kit	42894S	
Modbus RS-485 Expansion Kit	42897S	
User Interface Module (UIM)	42938-C21S	42938-C31S

Description	48V	
	4-Slot	8-Slot
Input AC Circuit Breaker, Standard	41931S (30A)	41933S (60A)
Input AC Circuit Breaker, High Interrupt	41932S (30A)	41934S (60A)
Output DC Circuit Breaker	41963S (50A)	
Intelligent Power Module (iPM)	41802-C02S	
Alarm Box Expansion Kit	42849S	
Alarm Box + Modbus RS-323 Expansion Kit	42852S	
Alarm Box + Modbus RS-485 Expansion Kit	42854S	
Modbus RS-323 Expansion Kit	42851S	
Modbus RS-485 Expansion Kit	42853S	
User Interface Module (UIM)	41593-C22S	41593-C32S

Description	130V		
	4-Slot	8-Slot	16-Slot (208-240V only)
Input AC Circuit Breaker, Standard	41931S (30A)	41933S (60A)	
Input AC Circuit Breaker, High Interrupt	41932S (30A)	41934S (60A)	
Output DC Circuit Breaker	41961S (25A)		
Intelligent Power Module (iPM)	41844-C02S		
Alarm Box Expansion Kit	42724S		
Alarm Box + Modbus RS-323 Expansion Kit	42727S		
Alarm Box + Modbus RS-485 Expansion Kit	42729S		
Modbus RS-323 Expansion Kit	42726S		
Modbus RS-485 Expansion Kit	42728S		
User Interface Module (UIM)	41593-C23S	41593-C33S	41593-C43S

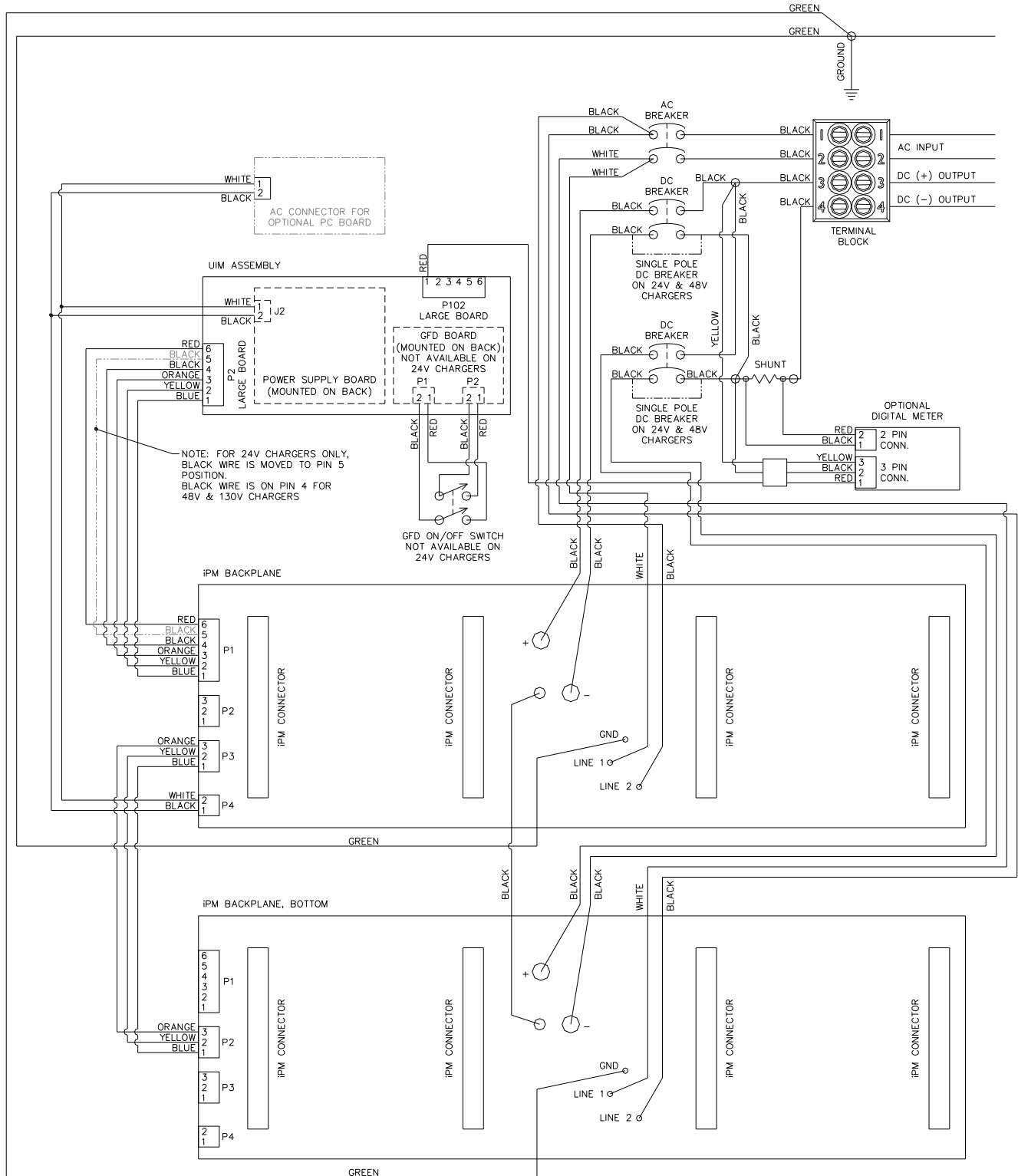
Description	All Models	
	19-inch Rack	23-inch Rack
Mounting Brackets, 4-slot chassis	41864S	42888S
Mounting Brackets, 8-slot chassis	41798S	42699S
Mounting Brackets, 16-slot chassis	42796S	42798S
Mounting Brackets, Stand, 4 & 8 slot chassis	43157S	
Remote Battery Temperature Cable, 10 Ft.	40974S	
Remote Battery Temperature Cable, 30 Ft.	40976S	
Remote Battery Voltage Cable, 10 Ft.	40977S	
Remote Battery Voltage Cable, 30 Ft.	40978S	
Terminal Block, Input and Output	43392S	
iPM, Blank, Cover Plate, 1 per	41838S	
Drip Shield	43041S	
Digital Display	42233S	
GFD ON/OFF Switch	42583S	

# 14. CHARGER WIRE DIAGRAMS



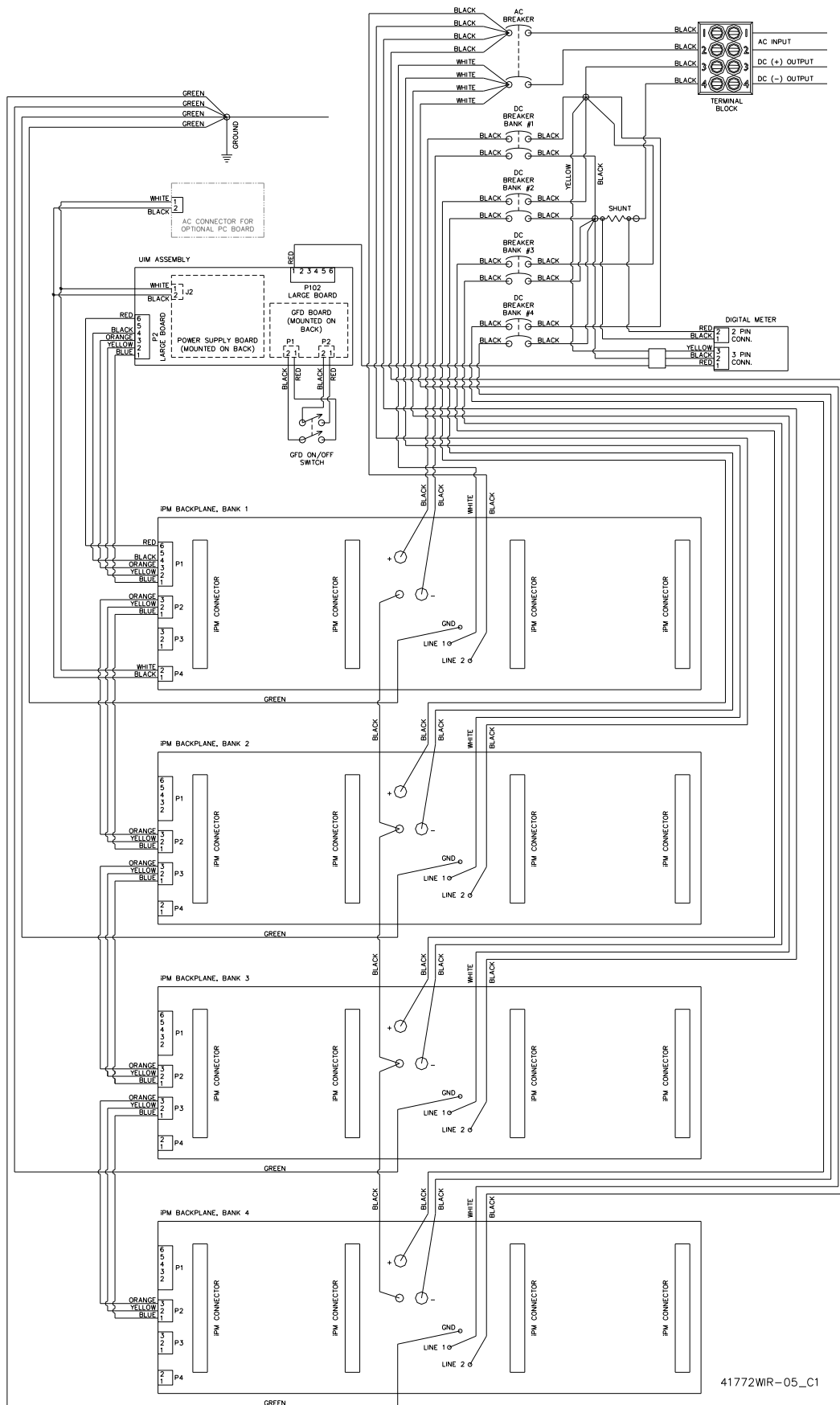
**Figure 14-1: Wire Diagram for 4-Slot Utility Chassis**

41772WIR-01\_D1



41772WIR-02\_D1

**Figure 14-2: Wire Diagram for 8-Slot Utility Chassis**



41772WIR-05\_C1

**Figure 14-3: Wire Diagram for 16-Slot Utility Chassis**



---

## 15. SPECIFICATIONS

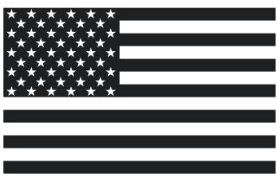
See the Eagle Eye BC-2500 datasheet for specifications.

## NOTES



**EAGLE EYE**  
POWER SOLUTIONS

**MADE IN**



**U. S. A.**

42192 L