

## Set-Up Instructions

### EAGLE SYSTEM (Liner-Based System)

**UL LISTED**

**Important**

*Read set-up instructions before assembly.*

**Installation Webinars Available  
800-206-9884**

**Sign Up at [www.egsintl.com](http://www.egsintl.com)  
Report any shortages within 72 hours**

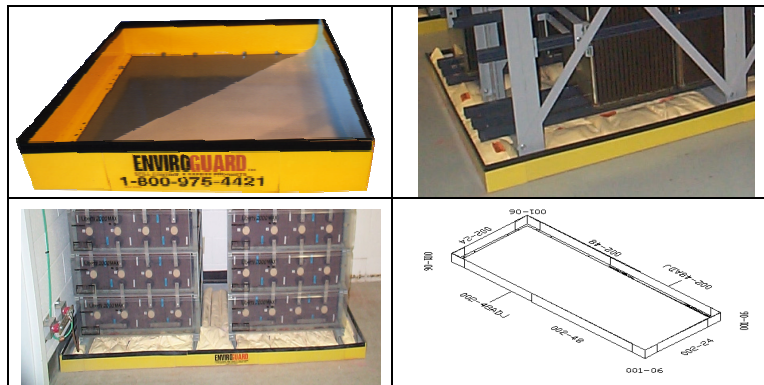





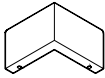
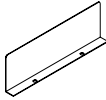
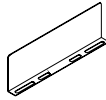
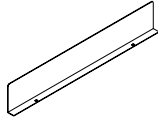
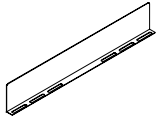
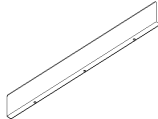
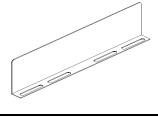
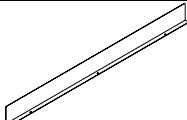
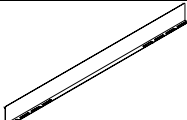

Specializing in Environmental and Fire-Life  
Safety Compliance for Stationary Battery  
Systems

# Table of Contents

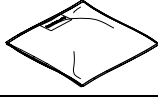
<b>Part Familiarization.....</b>	<b>2</b>
<b>Required Tools.....</b>	<b>3</b>
<b>Step 1 Verify Measurements.....</b>	<b>4</b>
<b>Step 2 Floor Preparation .....</b>	<b>4</b>
<b>Step 3 Liner Layout.....</b>	<b>5</b>
<b>Step 4 Rack &amp; Battery Installation.....</b>	<b>6</b>
<b>Step 5 Seal Rack &amp; Anchor Bolts.....</b>	<b>7</b>
<b>Step 6 Containment Layout .....</b>	<b>7</b>
<b>Step 7a Barrier Installation w/Anchor Bolts .....</b>	<b>8</b>
<b>Step 7b Barrier Installation with Adhesive Option .....</b>	<b>8</b>
<b>Step 8 Final Assembly – Extrusion Clips .....</b>	<b>9</b>
<b>Step 9 Pillow Installation.....</b>	<b>9</b>
<b>Installation Training.....</b>	<b>12</b>
<b>Maintenance.....</b>	<b>13</b>

**Product Familiarization  
Component Listing:**

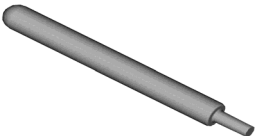
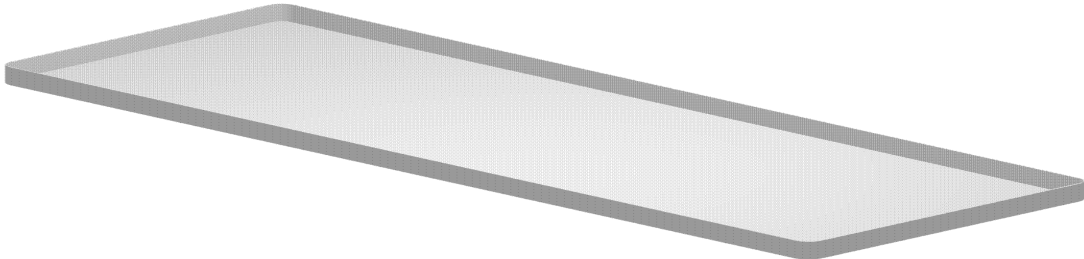
<b>EAGLE BARRIER WALLS</b>		
		
001-06	002-12	002-12ADJ
		
002-24		002-24ADJ
		
002-36		002-14ADJ
		
002-48		002-48ADJ
<b>PILLOWS</b>		
		
SOC		NABPILL
<b>FLOOR ANCHORING HARDWARE</b>		
		
1/4" Floor Anchor Bolt	Drop-In Floor Anchor	Floor Anchor Washer
		
	Anchor Setting Tool	
<b>UL LISTED FACTORY FORMED LINER</b>		
		
Corrosion Resistant Liner		

## **Tools Required for Installation**

- Anchor Setting tool (Provided)
- Caulking Gun (Provided)
- Hammer Drill
- Hammer
- Ratchet w/ 7/16" and 1/2" Sockets
- Chalk Line
- Duct Tape
- Non-Conductive Measuring Tape
- Marker
- Utility Knife with Regular or Hook Blades
- Side Cutters (Snips)
- Throw-away Latex Gloves
- Dust Pan and Hand Broom
- Vacuum
- Safety Glasses

# Level 1 “New Installations”

A “new installation” is defined by EnviroGuard as a spill containment installation where the battery rack has not yet been installed.

## NOTES:

1. Installations Utilizing Pre-Fabricated Corrosion Resistant Liner
2. This Procedure is for New Installations ONLY.
3. The gray side of the liner must face up.

## Step 1

### Verify Measurements

Prior to starting the job, review the CAD drawing and compare it with the actual kit. Verify measurements of the battery rack being used. If a problem exists, contact the necessary management. (This procedure should take place in the job walk; problems should have been identified then, check the job walk checklist)

## Step 2

### Floor Preparation

Clean floor thoroughly of any debris that may interfere with a tight seal between the floor and the spill containment barrier. Snap a chalk line according to spill containment outside dimensions to identify exact location. (Figure 1)



**Note:** Spill containment barrier walls must be at least 1” away from rack, VRLA stack or cabinet outside dimensions in all directions when job is complete.

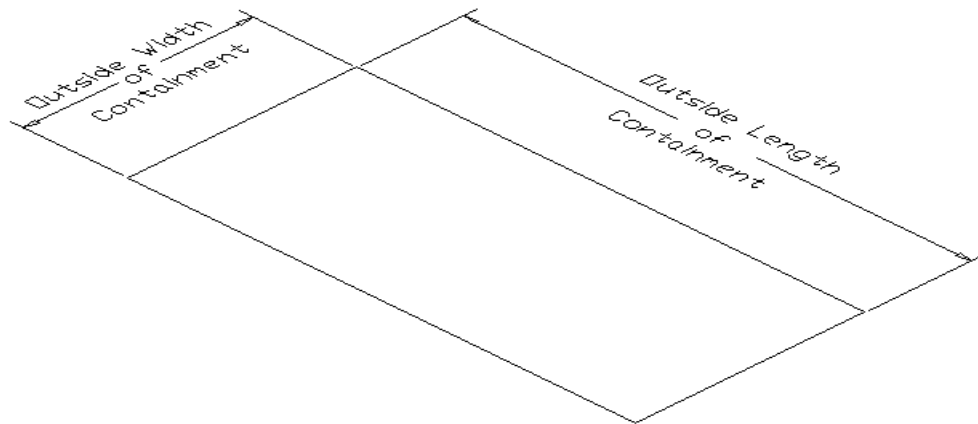
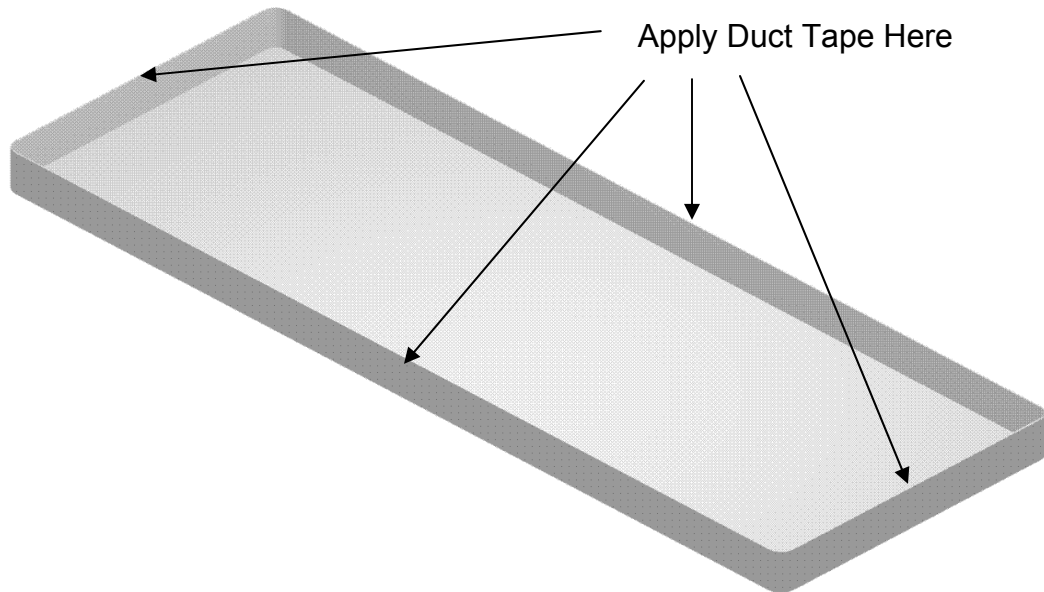

**Figure 1**

### Step 3

#### Liner Layout

Layout the liner, with gray side up, within the chalk line area and measure liner to confirm inside dimensions (Figure 2a). Using duct tape, secure the liner to the floor and remove wrinkles and folds (Figure 2b).



**Figure 2a**



**Figure 2b**

## Step 4

### Rack & Battery Installation

**Always check for rebar or underground obstructions before drilling!**

Assemble rack according to rack manufacture instructions. Center the rack on the inside of the liner. **Be very careful not to tear the liner by shifting the rack.** (Figure 3) Check to ensure distances from wall comply with local codes. The liner should extend beyond the rack evenly on all sides. (Figure 4) Verify aisle width and distance needed from wall. Mark the locations of the holes to be drilled for the rack. Drill holes for rack anchor bolts. Clean holes and remove debris.



Figure 3



**Centering the rack on the liner is very critical. If another installer is responsible for placing the rack, make sure it's centered prior to drilling.**

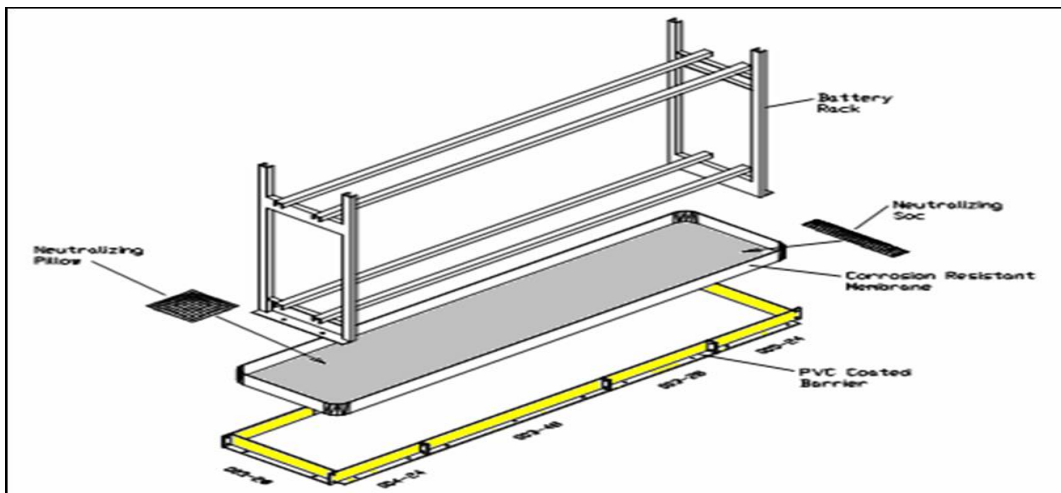

Figure 4

## Step 5

### Sealing Rack Anchor Bolts

Coat each rack anchor bolt with Acid Resistant sealant before placement. Insert anchor bolt through washer (Figure 5a). Run a bead of Acid-Resistant sealant around rack footprint and anchor bolts. Lay 1/8" Masonite sheet over the liner to protect liner from equipment and lifts. Set the batteries in the rack (Figure 5b). Remove Masonite and duct tape.

**Figure 5a**

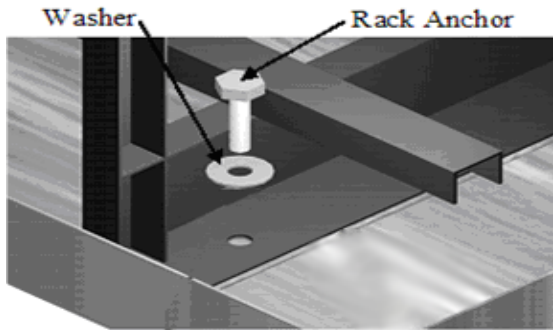

**Figure 5b**

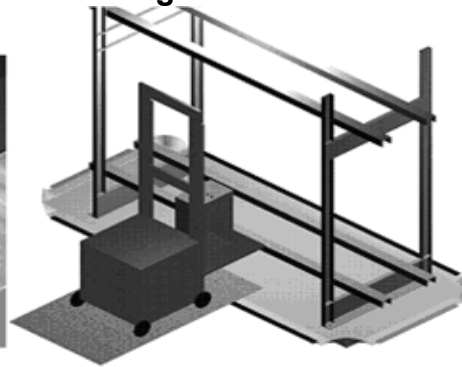

## Step 6

### Containment Layout

Lay out all "Eagle Barrier Walls" on the floor around the liner according to the CAD assembly drawing (Figure 6). Assemble the wall components by matching the labeled part numbers shown on the CAD drawing. For the required configuration, use the slots on the adjustable components for proper sizing. Use the Extrusion Clips to keep Barrier Walls in place during installation. Barrier Walls should be at least 1" away from rack in all directions. Using Barrier Wall components as a template mark the location of the holes to be drilled in the floor. Remove the Extrusion from the Barrier Walls. Remove the Barrier Walls carefully and note the orientation of the components.

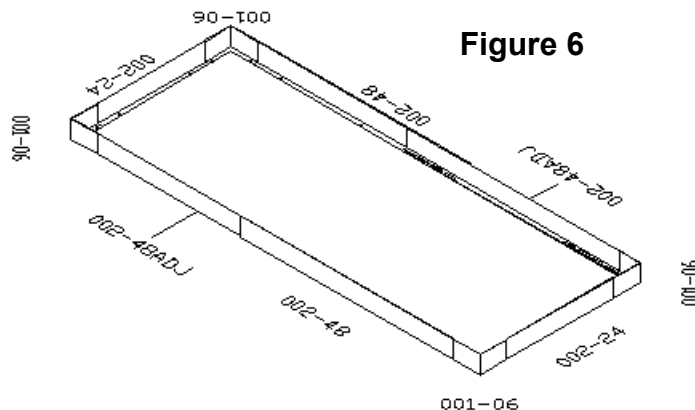

**Figure 6**

## Step 7a

### Drilling Holes & Installing Floor Anchors



**Always check for rebar or underground obstructions before drilling!**

Using the drill bit provided, drill holes to 1" depth at previously marked locations (Figure 7). Clean drill holes as you go using shop vacuum with Hepa Filter. Insert drop-in floor anchors and insure top of anchor is flush with floor.

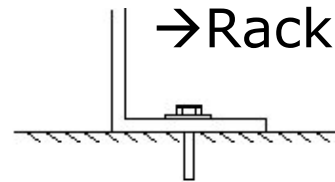
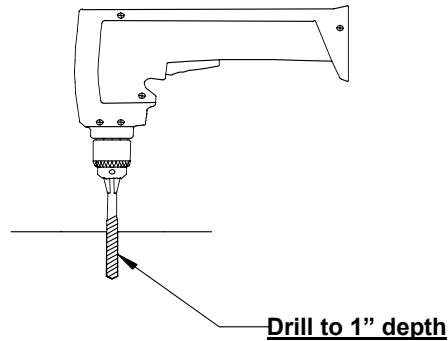

Place Barrier Walls back over the perimeter to check alignment and hole accuracy. Using the anchor punch tool set the drop-in floor anchors into the floor. After all components have been situated, continue to secure the remaining Barrier Walls to the floor by tightening the floor anchor assembly bolts, using a 7/16" socket, 110 inch pounds.

## Step 8

### Final Assembly

Place the Extrusion Clips over the top of the Barrier Wall securing the liner to the wall. In the event that height of the liner exceeds the Barrier Walls, trim the liner as necessary after liner has been pushed fully into containment. Continue installing the extrusion clips over Barrier Walls and liner (Figure 10).



**CAUTION: DO NOT USE BARRIER WALL AS A GUIDE TO TRIMMING!**

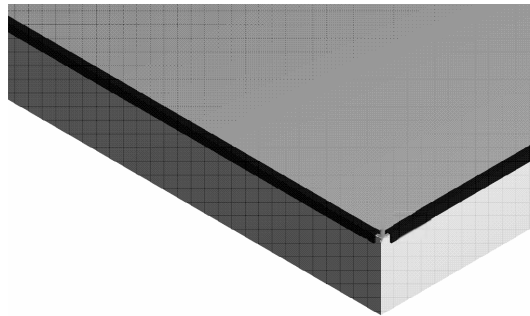

Figure 10

## Step 9

### Installing Neutralizing Pillows

Install pillows inside the floor of the liner. Spread pillows out to cover the maximum amount of space. Place serial numbers facing up and in the same direction whenever possible. Please note that the rack stanchions may interfere with uniform pillow layout (Figure 11).

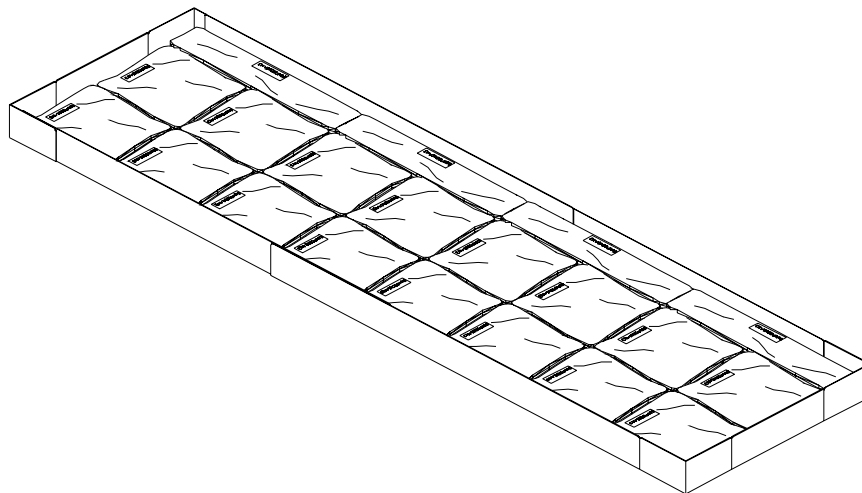

Figure 11

**Congratulations!**  
**This concludes the installation procedures for the EAGLE System**

**Certificate of Compliance**

Certificate Number **042303-E206284**  
Report Reference **E206284, April 23, 2003**  
Issue Date **2006 June 29**

Page 1 of 1



*Issued to:* **EnviroGuard**  
5534 OLIVE ST  
Montclair, CA 91763

*This is to certify that representative samples of*

**Spill Containment for Stationary Lead-Acid Battery**  
Spill containment systems, Models Eagle#, Condor Plus#, Hawk#.

# - May have alphanumeric suffix to describe overall containment area.

*Have been investigated by Underwriters Laboratories Inc.® in accordance with the Standard(s) indicated on this Certificate.*

*Standard(s) for Safety:*

In accordance with ASTM E648-99 - Standard Test Method for Critical Radiant Flux of Floor Covering Systems Using a Radiant Heat Energy Source.

*Additional Information:*

Only those products bearing the UL Classification Mark should be considered as being covered by UL's Classification and Follow-Up Service.

The UL Classification Mark includes: UL in a circle symbol:  with the word "CLASSIFIED" (as shown); a control number (may be alphanumeric) assigned by UL; a statement to indicate the extent of UL's evaluation of the product; and, the product category name (product identity) as indicated in the appropriate UL Directory.

**Look for the UL Classification Mark on the product**

Issued by:

**James J. Joyce, Staff Engineer**

Underwriters Laboratories Inc.

For questions in The United States of America you may call 1-877-UL-HELPS.

Reviewed by:

**Karen M. Dubiel, Engineering Group Leader**

Underwriters Laboratories Inc.

**Be sure to display your UL Certificate,  
supplied with the kit, in a conspicuous place  
for audits and inspections!**

**Be sure to display your UL  
Certificate in a conspicuous place  
for audits and inspections!**

## **Installation Training**

Installation Training for New and Retrofit Setup is highly recommended and a UL Requirement available through EnviroGuard. For additional information, availability and pricing, please call 800-206-9884 or go to [www.egsintl.com](http://www.egsintl.com).

### **Level 1 – New Installations (Online Training)**

This course presents a proven process for installing EnviroGuard's UL Listed spill containment systems that incorporate the latest technologies. Proper installation techniques are covered to ensure the system will be liquid-tight and reliable and maintain UL integrity. This 1-hour session covers battery room safety, tools required, a description of the various components and procedures that minimize installation time. Installation technicians will be able to confidently install EnviroGuard's spill containment systems for flooded, VRLA, battery cabinet and relay rack applications. Upon completion of a test, attendees will receive a certificate of completion and a personalized identification badge.

**Audience:** This course is designed for installation technicians, electricians, contractors and engineers.

**Course Length:** 1 Hour (45-minute presentation plus a 15-minute Q&A session)

**Delivery Format:** LIVE Webinar with technical staff. Sessions are presented using Internet On-Line collaboration with session presenters. (On-Site Staff available by special arrangement). Equipment required: a PC, Internet connection, web browser (Internet Explorer 6 or later recommended) and phone. Note: Phone conference utilizes a toll number.

#### **Course Outline:**

- Exercising good battery room safety practices
- Matching EnviroGuard spill containment systems by application
- Recognizing the components of EnviroGuard spill containment systems
- Properly installing EnviroGuard UL Listed Spill Containment Systems
- Knowing who to contact for technical support

### **Level 2 – Retrofit Installations (Online w/ Hands on Training)**

Retrofitting an existing system with batteries in place and live, requires care and special techniques. This course presents a proven technique and procedure to ensure minimal labor, maximum system integrity and a reliable, liquid-tight containment system. This course includes a classroom presentation and hands-on lab to fully prepare installers of the proper techniques and precautions for retrofitting a battery system. Upon completion of a test, attendees will receive a certificate of completion and a personalized identification badge.

**Audience:** This course is designed for installation technicians, electricians, contractors and engineers with a need to install spill containment at an existing battery system site.

**Course Length:** 6 Hours (2-hour classroom presentation/discussion plus a 4-hour, hands-on lab) (The lab session may optionally be coordinated with an actual retrofit project.)

**Delivery Format:** Instructor presentation and lab instruction at customer or installation site.

#### **Course Outline:**

- Safety practices working around live battery systems
- Proper technique and procedure for retrofit
- Thermo Bonding the Liner
- Maintenance Procedure

# Inspection & Maintenance

## Scheduled Maintenance

Once a year, EnviroGuard recommends inspection of all acid resistant approved sealant. EnviroGuard also recommends that a new bead of sealant be applied to the locations as specified in the setup instructions, as required. Acid Resistant sealant should be checked for cracks or leaks, due to concrete settlement and cracking expected with aging. Check that all bolts are tightened to 110 inch pounds and recoated rack mounting bolts as needed with sealant. A visual inspection of the neutralizing & absorption pillows should take place. **If the pillows or SOCs have turned color, they may be contaminated.** Any contaminated pillows or SOCs should be replaced immediately.

## Sealant Removal

In the event that removal of sealant is necessary, mineral spirits may be used to ease removal, however the best method is to use a putty knife and be very careful not to damage the liner. **Exercise extreme caution when using chemicals such as mineral spirits, as they can cause severe damage to batteries and equipment.**

## Pillow Inspection & Evaluation for Replacement

Neutralizing & Absorption Pillows are designed to react with sulfuric acid/electrolyte. Water and/or excessive humidity will, on occasion, cause discoloration. Contact with water over time may cause pillows to need replacing prematurely. It is recommended that absorption pillows and SOCs are replaced when replacing batteries. Ask about EnviroGuard's pillow credit recycling & disposal services nationwide at (800) 206-9884.

## Disassembly of Side Barriers Walls for Battery Service

**NOTE: The following procedure should be used for the removal or replacement of batteries. Always use protective equipment when servicing battery strings.**

Determine which Barrier Walls need to be removed for battery service. Extract the floor anchor assembly bolts from the components to be dislodged. Remove the Barrier Walls.

Lay a 1/8" Masonite sheet over the liner to protect liner from equipment and lifts. Remove batteries to be replaced or serviced. Set the batteries in the rack. Return the Barrier Walls to their previous location and replace floor anchor bolts. Tighten to 110 inch pounds.